

# marantz®

## Model DV4600 User Guide

---

DVD Player



## PRECAUTIONS

**WARNING** TO REDUCE THE RISK OF FIRE OR ELECTRIC SHOCK,  
DO NOT EXPOSE THIS PRODUCT TO RAIN OR MOISTURE.



**CAUTION**  
**RISK OF ELECTRIC SHOCK**  
**DO NOT OPEN**



**CAUTION:**

TO REDUCE THE RISK OF ELECTRIC SHOCK, DO NOT REMOVE COVER (OR BACK). NO USER-SERVICEABLE PARTS INSIDE. REFER SERVICING TO QUALIFIED SERVICE PERSONNEL.



The lightning flash with arrowhead symbol within an equilateral triangle is intended to alert the user to the presence of uninsulated "dangerous voltage" within the product's enclosure that may be of sufficient magnitude to constitute a risk of electric shock to persons.



The exclamation point within an equilateral triangle is intended to alert the user to the presence of important operating and maintenance (servicing) instructions in the literature accompanying the product.

**CAUTION:** TO PREVENT ELECTRIC SHOCK, MATCH WIDE BLADE OF PLUG TO WIDE SLOT, FULLY INSERT.

**ATTENTION:** POUR ÉVITER LES CHOCS ÉLECTRIQUES, INTRODUIRE LA LAME LA PLUS LARGE DE LA FICHE DANS LA BORNE CORRESPONDANTE DE LA PRISE ET POUSSER JUSQU'AU FOND.

**NOTE:**

This equipment has been tested and found to comply with the limits for a Class B digital device, pursuant to Part 15 of the FCC Rules. These limits are designed to provide reasonable protection against harmful interference in a residential installation. This equipment generates, uses and can radiate radio frequency energy and, if not installed and used in accordance with the instructions, may cause harmful interference to radio communications. However, there is no guarantee that interference will not occur in a particular installation. If this equipment does cause harmful interference to radio or television reception, which can be determined by tuning the equipment off and on, the user is encouraged to try to correct the interference by one or more of the following measures:

- Reorient or relocate the receiving antenna.
- Increase the separation between the equipment and receiver.
- Connect the equipment into an outlet on a circuit different from that to which the receiver is connected.
- Consult the dealer or an experienced radio/TV technician for help.

### LASER SAFETY

This unit employs a laser. Only a qualified service person should remove the cover or attempt to service this device, due to possible eye injury.

**CAUTION: USE OF CONTROLS OR ADJUSTMENTS OR PERFORMANCE OF PROCEDURES OTHER THAN THOSE SPECIFIED HERE MAY RESULT IN HAZARDOUS RADIATION EXPOSURE.**

**CAUTION** VISIBLE AND INVISIBLE LASER RADIATION WHEN OPEN AVOID EXPOSURE TO BEAM (WARNING LOCATION: INSIDE ON LASER COVERSIELD)

#### Information to User

Alteration or modifications carried out without appropriate authorization may invalidate the user's right to operate the equipment.

#### Operating Environment

Operating environment temperature and humidity:

+5 C to +35 C (+41 F to +95 F); less than 85%RH (cooling vents not blocked) Do not install in the following locations

- Location exposed to direct sunlight or strong artificial light
- Location exposed to high humidity, or poorly ventilated location

**NOTE:**

Changes or modifications not expressly approved by the party responsible for compliance could void the user's authority to operate the equipment.

**CAUTION:**

This product satisfies FCC regulations when shielded cables and connectors are used to connect the unit to other equipment. To prevent electromagnetic interference with electric appliances such as radios and televisions, use shielded cables and connectors for connections.

This product is for general household purposes. Any failure due to use for other than household purposes (such as long - term use for business purposes in a restaurant or use in a car or ship) and which requires repair will be changed for even during the warranty period.

Do not remove the cover from the equipment.  
Do not insert anything into the equipment through the ventilation holes.  
Do not handle the mains lead with wet hands.  
Make a space of about 0.1 meter around the unit.

#### IMPORTANT NOTICE

[For U.S. model]

The serial number for this equipment is located on the rear panel. Please write this serial number on your enclosed warranty card and keep it in a secure area. This is for your security.

# IMPORTANT SAFETY INSTRUCTIONS

## READ BEFORE OPERATING EQUIPMENT

This product was designed and manufactured to meet strict quality and safety standards. There are, however, some installation and operation precautions which you should be particularly aware of.

1. **Read Instructions** – All the safety and operating instructions should be read before the product is operated.
2. **Retain Instructions** – The safety and operating instructions should be retained for future reference.
3. **Heed Warnings** – All warnings on the product and in the operating instructions should be adhered to.
4. **Follow Instructions** – All operating and use instructions should be followed.
5. **Cleaning** – Unplug this product from the wall outlet before cleaning. Do not use liquid cleaners or aerosol cleaners. Use a damp cloth for cleaning.
6. **Attachments** – Do not use attachments not recommended by the product manufacturer as they may cause hazards.
7. **Water and Moisture** – Do not use this product near water—for example, near a bath tub, wash bowl, kitchen sink, or laundry tub, in a wet basement, or near a swimming pool, and the like.
8. **Accessories** – Do not place this product on an unstable cart, stand, tripod, bracket, or table. The product may fall, causing serious injury to a child or adult, and serious damage to the product. Use only with a cart, stand, tripod, bracket, or table recommended by the manufacturer, or sold with the product. Any mounting of the product should follow the manufacturer's instructions, and should use a mounting accessory recommended by the manufacturer.
9. **CART** – A product and cart combination should be moved with care. Quick stops, excessive force, and uneven surfaces may cause the product and cart combination to overturn.
10. **Ventilation** – Slots and openings in the cabinet are provided for ventilation and to ensure reliable operation of the product and to protect it from overheating, and these openings must not be blocked or covered. The openings should never be blocked by placing the product on a bed, sofa, rug, or other similar surface. This product should not be placed in a built-in installation such as a bookcase or rack unless proper ventilation is provided or the manufacturer's instructions have been adhered to.
11. **Power Sources** – This product should be operated only from the type of power source indicated on the marking label. If you are not sure of the type of power supply to your home, consult your product dealer or local power company. For products intended to operate from battery power, or other sources, refer to the operating instructions.
12. **Grounding or Polarization** – This product may be equipped with a polarized alternating-current line plug (a plug having one blade wider than the other). This plug will fit into the power outlet only one way. This is a safety feature. If you are unable to insert the plug fully into the outlet, try reversing the plug. If the plug should still fail to fit, contact your electrician to replace your obsolete outlet. Do not defeat the safety purpose of the polarized plug.
13. **Power-Cord Protection** – Power-supply cords should be routed so that they are not likely to be walked on or pinched by items placed upon or against them, paying particular attention to cords at plugs, convenience receptacles, and the point where they exit from the product.
14. **Protective Attachment Plug** – The product is equipped with an attachment plug having overload protection. This is a safety feature. See Instruction Manual for replacement or resetting of protective device. If replacement of the plug is required, be sure the service technician has used a replacement plug specified by the manufacturer that has the same overload protection as the original plug.
15. **Outdoor Antenna Grounding** – If an outside antenna or cable system is connected to the product, be sure the antenna or cable system is grounded so as to provide some protection against voltage surges and built-up static charges. Article 810 of the National Electrical Code, ANSI/NFPA 70, provides information with regard to proper grounding of the mast and supporting structure, grounding of the lead-in wire to an antenna discharge unit, size of grounding conductors, location of antenna-discharge unit, connection to grounding electrodes, and requirements for the grounding electrode. See Figure 1.
16. **Lightning** – For added protection for this product during a lightning storm, or when it is left unattended and unused for long periods of time, unplug it from the wall outlet and disconnect the antenna or cable system. This will prevent damage to the product due to lightning and power-line surges.

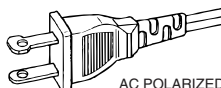

17. **Power Lines** – An outside antenna system should not be located in the vicinity of overhead power lines or other electric light or power circuits, or where it can fall into such power lines or circuits. When installing an outside antenna system, extreme care should be taken to keep from touching such power lines or circuits as contact with them might be fatal.
18. **Overloading** – Do not overload wall outlets, extension cords, or integral convenience receptacles as this can result in a risk of fire or electric shock.
19. **Object and Liquid Entry** – Never push objects of any kind into this product through openings as they may touch dangerous voltage points or short-out parts that could result in a fire or electric shock. Never spill liquid of any kind on the product.
20. **Servicing** – Do not attempt to service this product yourself as opening or removing covers may expose you to dangerous voltage or other hazards. Refer all servicing to qualified service personnel.
21. **Damage Requiring Service** – Unplug this product from the wall outlet and refer servicing to qualified service personnel under the following conditions:
  - a. When the power-supply cord or plug is damaged.
  - b. If liquid has been spilled, or objects have fallen into the product.
  - c. If the product has been exposed to rain or water.
  - d. If the product does not operate normally by following the operating instructions. Adjust only those controls that are covered by the operating instructions as an improper adjustment of other controls may result in damage and will often require extensive work by a qualified technician to restore the product to its normal operation.
  - e. If the product has been dropped or damaged in any way, and
  - f. When the product exhibits a distinct change in performance – this indicates a need for service.
22. **Replacement Parts** - When replacement parts are required, be sure the service technician has used replacement parts specified by the manufacturer or have the same characteristics as the original part. Unauthorized substitutions may result in fire, electric shock, or other hazards.
23. **Safety Check** – Upon completion of any service or repairs to this product, ask the service technician to perform safety checks to determine that the product is in proper operating condition.
24. **Wall or Ceiling Mounting** – The product should be mounted to a wall or ceiling only as recommended by the manufacturer.
25. **Heat** – The product should be situated away from heat sources such as radiators, heat registers, stoves, or other products (including amplifiers) that produce heat.

FIGURE 1  
EXAMPLE OF ANTENNA GROUNDING AS PER  
NATIONAL ELECTRICAL CODE, ANSI/NFPA 70

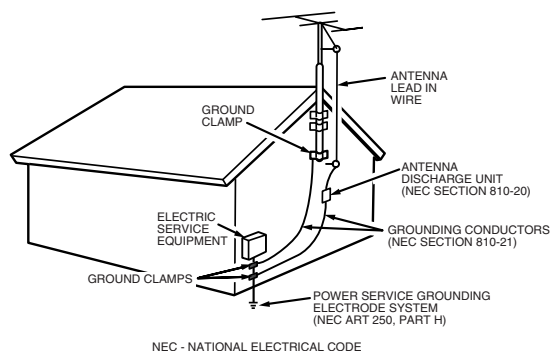

## TABLE OF CONTENTS

■ <b>PRECAUTIONS</b> .....	2	Zoom .....	16
LASER SAFETY .....	2	Title / Chapter Search .....	17
IMPORTANT SAFETY INSTRUCTIONS .....	3	By using the SEARCH MODE button .....	17
■ <b>INTRODUCTION</b> .....	5	By using the SKIP buttons ◀◀ ▶▶ .....	17
About Copyright .....	5	Track Search .....	17
Notice for the progressive scan outputs .....	5	By using the SEARCH MODE button .....	17
Supplied Accessories .....	5	By using the SKIP buttons ◀◀ ▶▶ .....	17
Symbols Used in this Manual .....	5	Time Search .....	17
■ <b>ABOUT THE DISCS</b> .....	6	Repeat .....	17
Playable Discs .....	6	REPEAT TITLE / CHAPTER .....	17
■ <b>FEATURES</b> .....	7	REPEAT TRACK / GROUP / ALL .....	18
■ <b>FUNCTIONAL OVERVIEW</b> .....	8	A-B REPEAT .....	18
FRONT PANEL .....	8	Program Playback (CD) .....	18
REMOTE CONTROL .....	8	Random Playback (CD) .....	18
Tour of the remote control .....	9	MP3 / JPEG / WMA Playback .....	18
Panel display .....	11	Slide Show Mode .....	20
Displays During Operation .....	11	On-Screen Information .....	20
Using the remote control .....	11	Program Playback (MP3 / JPEG / WMA) .....	20
Loading the Batteries .....	11	Random Playback (MP3 / JPEG / WMA) .....	21
■ <b>CONNECTIONS</b> .....	12	Audio Language .....	21
Description - rear panel .....	12	Stereo Sound Mode .....	21
Connection to an audio system .....	13	Subtitle Language .....	21
Connection to a TV (for video) .....	14	Camera Angle .....	22
■ <b>PLAYING A DISC</b> .....	15	Changing the On-Screen Display .....	22
Basic Playback .....	15	Marker Setup Screen .....	22
CANCELLING AND CALLING BACK		Virtual Surround .....	22
THE PBC FUNCTION .....	15	Black Level Setting .....	22
General Features .....	15	■ <b>DVD SETUP</b> .....	23
FL OFF Mode .....	15	Language Setting .....	23
Still / Pause .....	15	Display Setting .....	23
Disc Menus .....	15	Audio Setting .....	23
Title Menu .....	15	Parental Control .....	24
CALLING UP A MENU SCREEN DURING		PARENTAL LEVEL .....	24
PLAYBACK .....	15	IF YOU FORGET THE PASSWORD .....	24
Step by Step Playback .....	16	CONTROL LEVELS .....	24
Resume .....	16	Others Setting .....	24
Playing the disc recorded in VR mode		Reset to the Default Settings (except for PARENTAL) .....	24
(Video Recording format) .....	16	Language Code List .....	25
Fast Forward / Reverse Search .....	16	■ <b>MAINTENANCE</b> .....	25
Slow Forward / Slow Reverse .....	16	■ <b>TROUBLESHOOTING GUIDE</b> .....	26
		■ <b>SPECIFICATIONS</b> .....	27

**INTRODUCTION**

**A NOTE ABOUT RECYCLING:**

This product's packaging materials are recyclable and can be reused. Please dispose of any materials in accordance with your local recycling regulations.  
 When discarding the unit, comply with your local rules or regulations.  
 Batteries should never be thrown away or incinerated but disposed of in accordance with your local regulations concerning chemical wastes.



**Make your contribution to the environment!!!**

- Used up batteries do not belong in the dust bin.
- You can dispose of them at a collection point for used up batteries or special waste. Contact your council for details.

The serial number of this product may be found on the back of the DVD player. No others have the same serial number as yours. You should record the number and other vital information here and retain this book as a permanent record of your purchase to aid identification in case of theft. Serial numbers are not kept on file.

Date of Purchase	
Dealer Purchase from	
Dealer Address	
Dealer Phone No.	
Model No.	
Serial No.	

**About Copyright**

Unauthorized copying, broadcasting, public performance and lending of discs are prohibited. This product incorporates copyright protection technology that is protected by U.S. patents and other intellectual property rights. Use of this copyright protection technology must be authorised by Macrovision, and is intended for home and other limited viewing uses only unless otherwise authorised by Macrovision. Reverse engineering or disassembly is prohibited.





Apparatus Claims of U. S. Patent Nos, 4,631,603, 4,577,216, 4,819,098, and 4,907,093 licensed for limited viewing uses only.

**Notice for the progressive scan outputs**

Consumers should note that not all high definition television sets are fully compatible with this product and may cause artifacts to be displayed in the picture. In case of picture problems with 525 progressive scan output, it is recommended that the user switch the connection to the 'standard definition' output. If there are questions regarding your TV set compatibility with this 525p DVD player, please contact our customer service center.

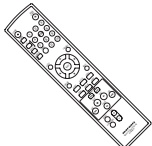
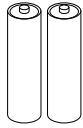
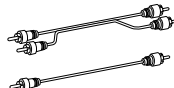
**Supplied Accessories**

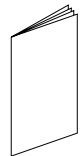
Please check to make sure the following items are included with the main unit in the carton.

Remote control..... 1 	"AA" (R6P) batteries ..... 2 	Audio (Red and White) cable..... 1 Video (Yellow) cable..... 1 	Remote Control bus cable (Orange) ..... 1 	User Guide ..... 1 	Warranty Card for USA..... 1 Warranty Card for Canada... 1 
--	---	--	--	--	--

**Symbols Used in this Manual**

The following symbols appear below in some headings and notes in this manual, with the following meanings.

- |                |   |                 |   |
|----------------|---|-----------------|---|
| <b>DVD-V</b> : | Description refers to playback of DVD-Video discs.          | <b>JPEG</b> :   | Description refers to viewing of JPEG discs.                            |
| <b>CD</b> :    | Description refers to playback of Audio CDs.                | <b>WMA</b> :    | Description refers to playback of discs formatted with WMA.             |
| <b>MP3</b> :   | Description refers to playback of discs formatted with MP3. | <b>DVD-RW</b> : | Description refers to playback of the VR mode (Video Recording format). |
| <b>VCD</b> :   | Description refers to playback of Video CDs.                |                 |   |

# ABOUT THE DISCS

## Playable Discs

Playable discs	Mark (logo)	Region code	Recorded signals	Disc size	Disc types
DVD-Video * 1, 2, 3, 5		or	Digital video	12 cm or 8 cm	
DVD-RW DVD-R * 1, 3, 4, 5, 6, 7, 8	 	-			
Video CD * 1, 3, 5, 9		-	Sound and Picture	12 cm or 8 cm	
Audio CD * 4, 5		-	Digital audio		
CD-RW CD-R * 4, 5, 7	 	-	Digital audio MP3 WMA*10 Digital picture (JPEG)		
Picture CD		-	JPEG	12 cm	



is a trademark of DVD Format/Logo Licensing Corporation.



is trademark of Eastman Kodak Company.



This label indicates playback compatibility with DVD-RW discs recorded in VR mode (Video Recording format).



Windows Media and the Windows logo are trademarks or registered trademarks of Microsoft Corporation in the United States and/or other countries.

This unit is not compatible with Multiple Bit Rate (MBR: a file that contains the same content encoded at several different bit rates).

### If you cannot play back a disc which bears one of the marks above, check the following notes.

- \*1: This player conforms to the NTSC color system. Also you can play discs recorded with the PAL system via a PAL system TV set.
- \*2: Certain DVD-Video discs do not operate as described in this manual due to the intentions of the disc's producers.
- \*3: Scratched or stained discs may not be played back.
- \*4: Some discs cannot be played back because of incompatible recording conditions, characteristics of the recorder or special properties of discs.
- \*5: You can play back discs which bear the marks above. If you use nonstandardized discs, this unit may not play them back. Even if they are played back, the sound or video quality will be compromised.
- \*6: Only the discs recorded in the video format or Video Recording format, and finalized can be played back. Unfinalized discs cannot be played back. Depending on the recording status of a disc, the disc may not be played back at all or normally (the picture or sound may be distorted, etc.).
- \*7: If there is too much recordable space left on a disc (the used portion is less than 55mm across), it may not play back properly.
- \*8: Do not glue paper or put stickers on to the disc. These may damage the disc, and the unit may not read it correctly.
- \*9: This unit conforms to ver.1.1 and ver.2.0 of Video CD standard with PBC function.  
*Ver.1.1 (without PBC function):* You can enjoy playback picture as well as music CD.  
*Ver.2.0 (with PBC function):* While using a Video CD with PBC function, "Pbc" appears on the screen and the display.  
**NOTE:** When playing Video CDs with PBC function, some operations (e.g., track search and repeat tracks) cannot be performed. Cancel PBC function temporarily to perform those operations (refer to page 15).

**What is PBC?** "PBC" stands for Playback Control.

You can play interactive software using menu screens. Refer to instructions in the Video CD.

\*10: This player cannot play the disc contents protected by Windows Media Digital Rights Management (DRM).

**NOTE:** This player cannot play the DVD-RW discs that supports CPRM (Content Protection for Recordable Media).

This player cannot play the DVD-R discs recorded in VR mode (Video Recording Format).

- **NEVER play back the following discs. Otherwise, malfunction may result!**  
 DVD-RAM / CD-I / Photo CD / DVD with region codes other than 1 or ALL / DVD-ROM for personal computers / CD-ROM for personal computers

- **On the following disc, the sound MAY NOT be heard.**

Super Audio CD

#### NOTES:

- Only the sound recorded on the normal CD layer can be delivered.
- The sound recorded on the high density Super Audio CD layer cannot be delivered.

- Any other discs without compatibility indications

#### CAUTION:

- Use caution not to pinch your finger in the disc slot.
- Be sure to remove a disc and unplug the AC power cord from the outlet before carrying the DVD player.



## FEATURES

- **Progressive Scan system**

Unlike conventional interlace scanning, the progressive scan system provides less flickering and images in higher resolution than that of traditional 525i television signals.

- **Dolby Digital Sound**

By hooking this player up to a Multi - Channel Dolby Digital decoder, you can enjoy high-quality Dolby Digital 5.1 channel surround sound as heard in the movie theaters.

- **DTS (Digital Theater System)**

When this player is connected to the DTS decoder, you can enjoy 5.1 channel surround system which reproduces the original sound as truthfully as possible. 5.1 channel surround system is developed by the Digital Theater System, Inc.

- **Still/fast/slow/step playback**

Various playback modes are available including still pictures, fast forward/reverse, slow motion and step frames.

- **Random Playback for Audio CD, MP3, JPEG, and WMA**

This player can shuffle the order of tracks to play them in random order.

- **Program Playback for Audio CD, MP3, JPEG, and WMA**

You can program the order of tracks to play them in any desired order.

- **DVD menus in a desired language**

You can display DVD menus in a desired language, if available on a DVD.

- **Auto Power Off**

The power turns off automatically if there is no activity at the player or its remote for more than 30 minutes. (Refer to page 24.)

- **Subtitles in a desired language**

You can select a desired language for the display subtitles, if that language is available on a disc.

- **Selecting a camera angle**

You can select the desired camera angle, if a disc contains sequences recorded from different angles.

- **Choices for audio language and sound mode**

You can select the desired audio language and sound mode, if different languages and modes are available on a disc.

- **Parental lock**

You can set the control level to limit playback of discs which may not be suitable for children.

- **Automatic detection of discs**

This player automatically detects if a loaded disc is DVD-Video, Video CD, Audio CD, MP3, JPEG, or WMA.

- **Playing an MP3 disc**

You can enjoy MP3 files which are recorded on CD-R/RW.

- **Direct Search**

You can search the desired title, chapter, and track with the numeric buttons during playback or in stop mode.

- **On-screen display**

Information about the current operation can be displayed on a TV screen, allowing you to confirm the currently active functions (such as program playback), on the TV screen using the remote control.

- **FL OFF Mode**

You can turn off the panel display.

- **Search**

Chapter search: Search for the chapter designated by user is possible.

Title search: Search for the title designated by user is possible.

Track search: Search for the track designated by user is possible.

Time search: Search for the time designated by user is possible.

- **Repeat**

Chapter: Repeated playback of the chapter of the disc being played is possible.

Title: Repeated playback of the title of the disc being played is possible.

Track: Repeated playback of the track of the disc being played is possible.

All: Repeated playback of the entire disc is possible (exclude DVD-Video).

A-B: The part between A and B designated by user is possible.

Group: Repeated playback of the folder of the MP3/JPEG/WMA disc being played is possible.

- **Zoom**

2-time or 4-time magnified screen can be displayed.

- **Marker**

The part designated by user can be called back.

- **Resume Play**

You can resume playback from the point at which the play has been stopped even if the power is turned off.

- **Component Video Out Jacks**

Jacks located on the back of the DVD Player which are used to send high-quality video to a TV via Component Video In Jacks.

- **Bit rate indication**

- **DRC (Dynamic Range Control)**

You can compress the range of sound volume.

- **Displaying a JPEG picture**

Kodak Picture CDs can be played. Still images stored in JPEG format on CD-R/RW can also be played.

- **Reproducing WMA data**

You can enjoy WMA files which are recorded on CD-R/RW.

- **PAL disc playback**

You can play discs recorded with the PAL system via a PAL system TV set.

Manufactured under license from Dolby Laboratories. "Dolby" and the double-D symbol are trademarks of Dolby Laboratories.

"DTS" and "DTS Digital Out" are trademarks of Digital Theater Systems, Inc.

"WMA" (Windows Media Audio) is a new audio codec developed by Microsoft® in the United States of America.

## FUNCTIONAL OVERVIEW

### FRONT PANEL

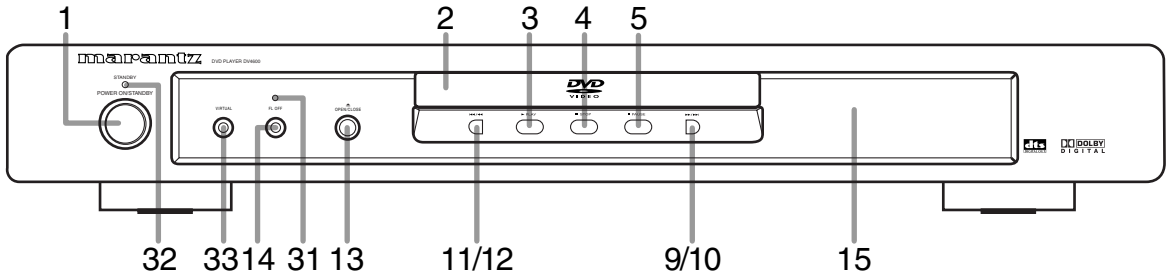

### REMOTE CONTROL

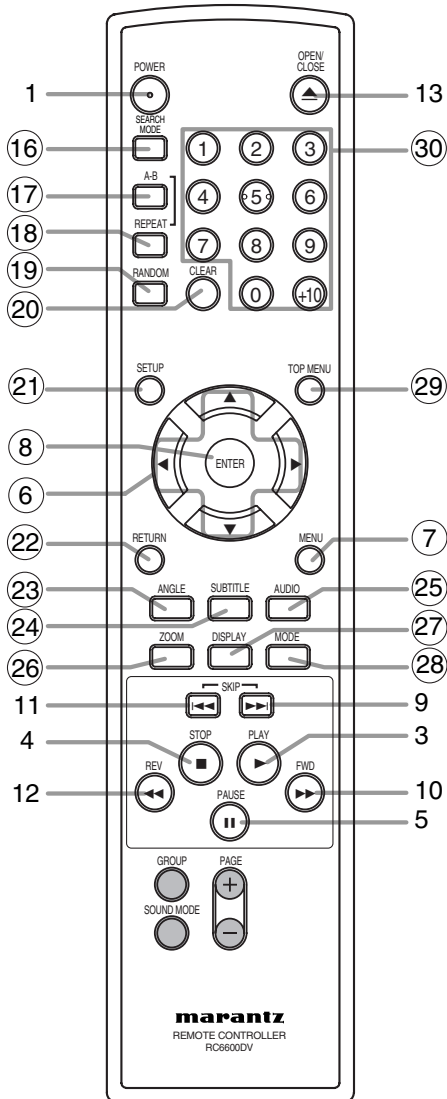

#### NOTES:















- The buttons in gray (●) do not function on this player.
- The buttons with circled numbers can only be operated with the remote control.

1. **POWER (ON/STANDBY) Button** [page 15]
2. **Disc loading tray**
3. **PLAY Button** [page 15]
4. **STOP Button** [page 15]
5. **PAUSE Button** [page 15]
6. **Cursor Buttons** [page 15]  
Use when making settings while watching the display on a TV screen.
7. **MENU Button** [page 15]
8. **ENTER Button** [page 15]
9. **▶▶(SKIP UP) Button** [page 17]  
Plays back from the beginning of the next chapter or track.
10. **▶▶(FWD SEARCH) Button** [page 16]  
Press more than 2 seconds when you use the front panel button for this function.
11. **◀◀(SKIP DOWN) Button** [page 17]  
Plays back from the beginning of the current chapter or track.
12. **◀◀(REV SEARCH) Button** [page 16]  
Press more than 2 seconds when you use the front panel button for this function.
13. **OPEN/CLOSE Button** [page 15]
14. **FL OFF Button** [page 15]
15. **Panel Display, Remote Sensor Window**
16. **SEARCH MODE Button** [page 17]
17. **A-B REPEAT Button** [page 18]
18. **REPEAT Button** [page 17]
19. **RANDOM Button** [page 18]
20. **CLEAR Button** [page 17]
21. **SETUP Button** [page 23]
22. **RETURN Button** [page 15]
23. **ANGLE Button** [page 22]  
Press to change the camera angle to see the sequence being played back from a different angle.
24. **SUBTITLE Button** [page 21]  
Press to select a desired subtitle language.
25. **AUDIO Button** [page 21]  
Press to select a desired audio language or sound mode.
26. **ZOOM Button** [page 16]
27. **DISPLAY Button** [page 20]
28. **MODE Button** [page 18]
29. **TOP MENU Button** [page 15]
30. **Numeric Buttons** [page 15]
31. **FL OFF Indicator**  
This indicator lights when the FL OFF button is ON.
32. **STANDBY Indicator**  
This indicator lights when the DVD player turns off.
33. **VIRTUAL Button** [page 22]





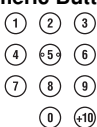







## Tour of the remote control

Buttons on remote control work in different ways for DVD, VCD, CD, MP3, JPEG, and WMA:  
Refer to the following table for correct use.

	DVD	VCD	CD, MP3, JPEG, WMA
<b>POWER Button</b> <small>POWER</small> 	<ul style="list-style-type: none"> <li>To switch the power between on and standby.</li> </ul>	<ul style="list-style-type: none"> <li>To switch the power between on and standby.</li> </ul>	<ul style="list-style-type: none"> <li>To switch the power between on and standby.</li> </ul>
<b>A-B REPEAT Button</b> <small>A-B</small> 	<ul style="list-style-type: none"> <li>To mark a segment between A and B for repeated playback.</li> </ul>	<ul style="list-style-type: none"> <li>To mark a segment between A and B for repeated playback.</li> </ul>	<ul style="list-style-type: none"> <li>To mark a segment between A and B for repeated playback (CD).</li> </ul>
<b>REPEAT Button</b> <small>REPEAT</small> 	<ul style="list-style-type: none"> <li>To repeat playback of a title or chapter.</li> </ul>	<ul style="list-style-type: none"> <li>To repeat playback of a track or disc.</li> </ul>	<ul style="list-style-type: none"> <li>To repeat playback of a track, group (MP3, JPEG, WMA) or disc.</li> </ul>
<b>RANDOM Button</b> <small>RANDOM</small> 	—	—	<ul style="list-style-type: none"> <li>To play tracks in random order.</li> </ul>
<b>MODE Button</b> <small>MODE</small> 	<ul style="list-style-type: none"> <li>To activate the 3D sound (Virtual Surround system).</li> <li>To set the Black Level Setting.</li> </ul>	<ul style="list-style-type: none"> <li>To activate the 3D sound (Virtual Surround system).</li> <li>To set the Black Level Setting.</li> </ul>	<ul style="list-style-type: none"> <li>To program a specific playback order.</li> <li>To activate the 3D sound (Virtual Surround system) (CD, MP3, WMA).</li> <li>To activate the Slide Show mode (JPEG).</li> </ul>
<b>ZOOM Button</b> <small>ZOOM</small> 	<ul style="list-style-type: none"> <li>To magnify part of the picture (x2/x4).</li> </ul>	<ul style="list-style-type: none"> <li>To magnify part of the picture (x2).</li> </ul>	<ul style="list-style-type: none"> <li>To magnify part of the picture (x2) (JPEG).</li> </ul>
<b>ANGLE Button</b> <small>ANGLE</small> 	<ul style="list-style-type: none"> <li>To access various camera angles on the disc.</li> </ul>	—	—
<b>SUBTITLE Button</b> <small>SUBTITLE</small> 	<ul style="list-style-type: none"> <li>To access various subtitles on the disc.</li> </ul>	—	—
<b>AUDIO Button</b> <small>AUDIO</small> 	<ul style="list-style-type: none"> <li>To access various audio functions on the disc.</li> </ul>	<ul style="list-style-type: none"> <li>To select STEREO, L-ch or R-ch.</li> </ul>	<ul style="list-style-type: none"> <li>To select STEREO, L-ch or R-ch. (CD)</li> </ul>
<b>DISPLAY Button</b> <small>DISPLAY</small> 	<ul style="list-style-type: none"> <li>To display the current disc mode.</li> </ul>	<ul style="list-style-type: none"> <li>To display the current disc mode.</li> </ul>	<ul style="list-style-type: none"> <li>To display the current disc mode.</li> </ul>
<b>SEARCH MODE Button</b> <small>SEARCH MODE</small> 	<ul style="list-style-type: none"> <li>To search for a chapter, title, time or marker.</li> <li>To rapidly return to a location on the disc.</li> </ul>	<ul style="list-style-type: none"> <li>To search for a track, time or marker.</li> <li>To rapidly return to a location on the disc.</li> </ul>	<ul style="list-style-type: none"> <li>To search for a track.</li> <li>To search for time or a marker (CD).</li> <li>To rapidly return to a location on the disc.</li> </ul>
<b>OPEN/CLOSE Button</b> <small>OPEN/CLOSE</small> 	<ul style="list-style-type: none"> <li>To open or close the disc tray.</li> </ul>	<ul style="list-style-type: none"> <li>To open or close the disc tray.</li> </ul>	<ul style="list-style-type: none"> <li>To open or close the disc tray.</li> </ul>
<b>Numeric Buttons</b> 	<ul style="list-style-type: none"> <li>To select a chapter or title directly.</li> </ul>	<ul style="list-style-type: none"> <li>To select a track directly.</li> </ul>	<ul style="list-style-type: none"> <li>To select a track directly.</li> </ul>
<b>CLEAR Button</b> <small>CLEAR</small> 	<ul style="list-style-type: none"> <li>To clear the markers.</li> <li>To clear the numbers entered incorrectly.</li> <li>To cancel the A point for A-B Repeat.</li> </ul>	<ul style="list-style-type: none"> <li>To clear the markers.</li> <li>To clear the numbers entered incorrectly.</li> <li>To cancel the A point for A-B Repeat.</li> </ul>	<ul style="list-style-type: none"> <li>To clear the markers. (CD)</li> <li>To remove a status number in program input.</li> <li>To clear the numbers entered incorrectly.</li> <li>To cancel the A point for A-B Repeat. (CD)</li> </ul>

**Tour of the remote control**

	<b>DVD</b>	<b>VCD</b>	<b>CD, MP3, JPEG, WMA</b>
<b>MENU Button</b> 	<ul style="list-style-type: none"> <li>To call up the Menu on a disc.</li> </ul>	—	<ul style="list-style-type: none"> <li>To call up the FILE LIST (MP3, JPEG, WMA).</li> </ul>
<b>TOP MENU Button</b> 	<ul style="list-style-type: none"> <li>To call up the Top Menu on a disc.</li> </ul>	—	<ul style="list-style-type: none"> <li>To return to the first item in the highest hierarchy of the FILE LIST (MP3, JPEG, WMA).</li> </ul>
<b>ENTER, Cursor Buttons</b> 	<ul style="list-style-type: none"> <li>To move the cursor and determine its position.</li> </ul>	<ul style="list-style-type: none"> <li>To move the cursor and determine its position.</li> </ul>	<ul style="list-style-type: none"> <li>To move the cursor and determine its position.</li> </ul>
<b>RETURN Button</b> 	<ul style="list-style-type: none"> <li>To return to the previous menu in the Setup menu.</li> </ul>	<ul style="list-style-type: none"> <li>To return to the previous menu in the Setup menu.</li> </ul>	<ul style="list-style-type: none"> <li>To return to the previous menu in the Setup menu.</li> </ul>
<b>SETUP Button</b> 	<ul style="list-style-type: none"> <li>To call up the DVD player's Setup menu.</li> </ul>	<ul style="list-style-type: none"> <li>To call up the DVD player's Setup menu.</li> </ul>	<ul style="list-style-type: none"> <li>To call up the DVD player's Setup menu.</li> </ul>
<b>SKIP Buttons</b> 	<ul style="list-style-type: none"> <li>To skip Chapters/Titles.</li> </ul>	<ul style="list-style-type: none"> <li>To skip Tracks.</li> </ul>	<ul style="list-style-type: none"> <li>To skip Tracks.</li> </ul>
<b>REV / FWD Buttons</b> 	<ul style="list-style-type: none"> <li>To search forward/backward through a disc.</li> <li>To begin slow forward/slow reverse.</li> </ul>	<ul style="list-style-type: none"> <li>To search forward/backward through a disc.</li> <li>To begin slow forward.</li> </ul>	<ul style="list-style-type: none"> <li>To search forward/backward through a disc. (CD, MP3, WMA).</li> </ul>
<b>STOP Button</b> 	<ul style="list-style-type: none"> <li>To stop playback.</li> </ul>	<ul style="list-style-type: none"> <li>To stop playback.</li> </ul>	<ul style="list-style-type: none"> <li>To stop playback.</li> </ul>
<b>PLAY Button</b> 	<ul style="list-style-type: none"> <li>To begin playback.</li> </ul>	<ul style="list-style-type: none"> <li>To begin playback.</li> </ul>	<ul style="list-style-type: none"> <li>To begin playback.</li> </ul>
<b>PAUSE Button</b> 	<ul style="list-style-type: none"> <li>To pause playback.</li> <li>To advance playback one frame at a time.</li> </ul>	<ul style="list-style-type: none"> <li>To pause playback.</li> <li>To advance playback one frame at a time.</li> </ul>	<ul style="list-style-type: none"> <li>To pause playback.</li> </ul>

**FUNCTIONAL OVERVIEW**

**Panel display**

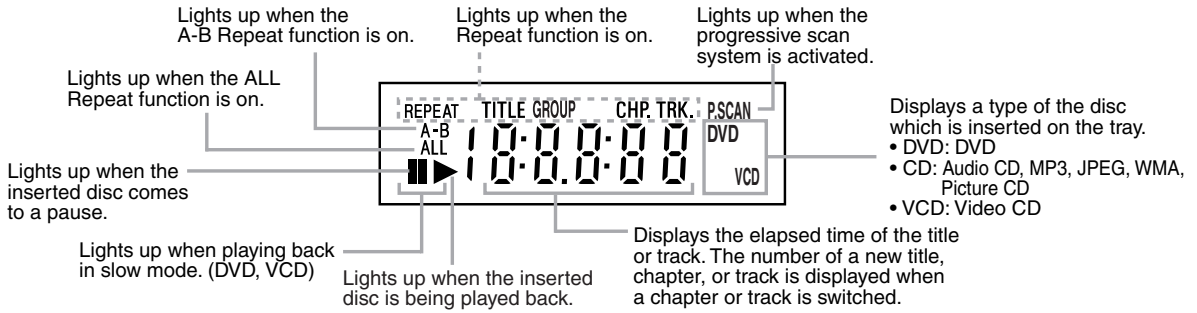

**Displays During Operation**

	Power on
	No disc inserted or cannot read
	Tray open
	Tray closed
	Loading the Disc
	Lights up when the playback control is activated (VCD)
	Power off

**Using the remote control**

Keep in mind the following when using the remote control:

- Make sure that there is no obstacle between the remote and the remote sensor on the unit.
- Use within the operating range and angle, as shown.

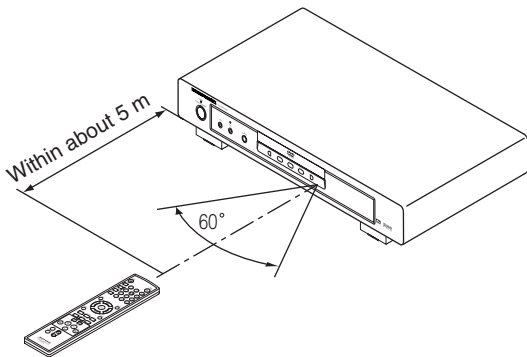

**Loading the Batteries**

1. Open the battery compartment cover.
2. Insert two "AA" (R6P) batteries, with each one oriented correctly.
3. Close the cover.

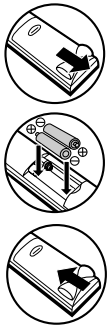

**Cautions On Batteries**

- Use "AA" (R6P) batteries in this remote control unit.
- Replace the batteries with new ones approximately once a year, though this depends on the frequency with which the remote control unit is used.
- If the remote control unit does not operate from close to the main unit, replace the batteries with new ones, even if less than a year has passed.
- The included batteries are only for verifying operation. Replace them with new batteries as soon as possible.
- When inserting the batteries, be careful to do so in the proper direction, following the ⊕ and ⊖ marks in the remote control unit's battery compartment.
- To prevent damage or battery fluid leakage:
  - Do not use a new battery with an old one.
  - Do not use two different types of batteries such as alkaline and manganese.
  - Do not short-circuit, disassemble, heat or dispose of batteries in flames.
- Remove the batteries when not planning to use the remote control unit for a long period of time.
- If the batteries should leak, carefully wipe off the fluid from the inside of the battery compartment, then insert new batteries.

## Description - rear panel

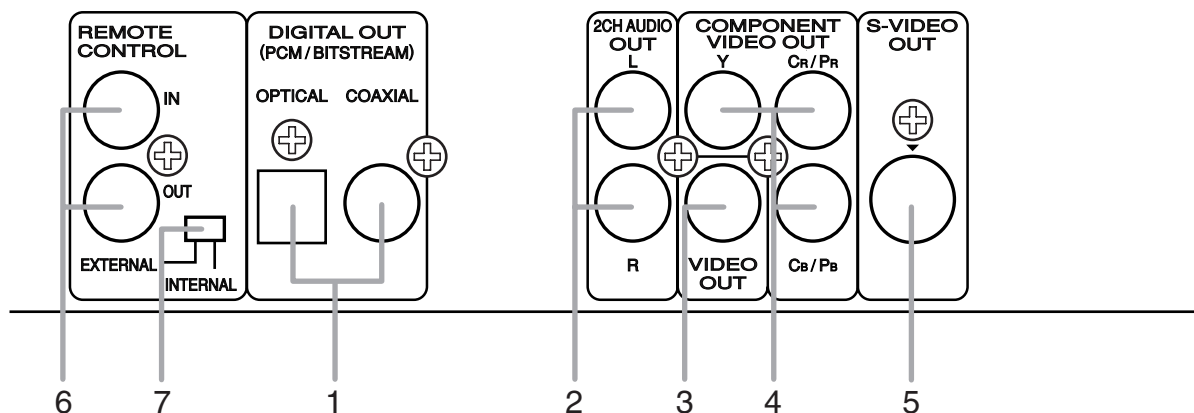

### 1. DIGITAL OUT Jacks

Use either an optical or coaxial digital cable to connect to an AV amplifier with a built-in decoder (AV control center).

### 2. 2CH AUDIO OUT Jacks

Connect to the Audio input jacks of A/V-compatible TV or wide screen TV, Stereo system.

### 3. VIDEO OUT Jack

Use a video cable to connect one of the jacks to Video input on your A/V-compatible TV, wide screen TV or Stereo system.

### 4. COMPONENT VIDEO OUT Jacks

Use these jacks if you have a TV with Component Video in jacks. These jacks provide C<sub>r</sub>/P<sub>r</sub>, C<sub>b</sub>/P<sub>b</sub> and Y video. Along with S-Video, Component Video provides the best picture quality.

### 5. S-VIDEO OUT Jack

Use the S-Video cable to connect this jack to the S-Video jack on your A/V-compatible TV or wide screen TV for a higher quality picture.

### 6. REMOTE CONTROL IN/OUT Jacks

By connecting this DVD player to another Marantz audio component using a supplied Remote Control bus cable, you can remotely operate the components as a signal system.

### 7. REMOTE CONTROL EXTERNAL / INTERNAL Switch

Set this switch to "INTERNAL" when using this DVD player independently. If you use this DVD player in a system with a Marantz receiver equipped with a remote sensor, set the switch to "EXTERNAL".

## NOTES:

- When connecting to component with a remote sensor, be sure to connect the REMOTE CONTROL IN jack of this DVD player to the REMOTE CONTROL OUT jack of the component.
- When connecting to component without a remote sensor, be sure to connect the component to the REMOTE CONTROL OUT jack of this DVD player.

## Selecting Progressive Scan (525p/480p or Interlaced 525i/480i) Playback

- If your TV is compatible with progressive scanning (525p/480p), connect the TV to the COMPONENT VIDEO OUT jacks of the DVD player and set "PROGRESSIVE" to "ON" in the display setting. Next, set your TV to the progressive scan mode. Refer to page 23 for instructions on changing the display setting.
- If your TV is not compatible with progressive scanning, set "PROGRESSIVE" to "OFF".
- Use a commercially available adaptor if the video input jacks of your TVs or monitors are the BNC type.

## What is Progressive Scanning?

- Unlike conventional interlace scanning, the progressive scan system provides less flickering and images in higher resolution than that of traditional (525i/480i) television signals.

## CONNECTIONS

The following show examples of connections commonly used to connect the DVD player to TV and other components.

If using this DVD player to play back a DVD in a Dolby Digital 5.1 channel surround or DTS surround format, the DVD player outputs a Dolby Digital or DTS data stream from its OPTICAL or COAXIAL DIGITAL OUT jacks. By hooking the player up to a Dolby Digital or DTS decoder, you can enjoy a more convincing, realistic ambience with powerful and high-quality surround sound of a professional standard, which can be heard in movie theaters. Use an audio coaxial or optical digital cable (not included) for the audio connections.

### NOTES:

- Be sure to turn off the power to all components in the system before connecting another component.
- Refer to the Instruction Manuals for your TV, Stereo system and any other components to be connected to the DVD player.

### Connection to an audio system

#### Method 1

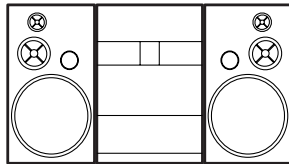

Stereo system

#### Method 2

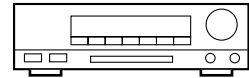

Dolby Digital decoder  
or DTS decoder

### AUDIO

Audio Input  
Jacks

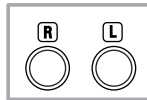

Audio cable  
(supplied)

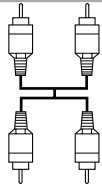

### DVD

(Analog)  
AUDIO OUT



Digital Audio  
Input Jacks

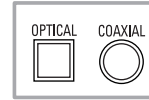

Optical cable  
(commercially  
available)

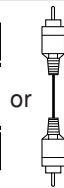

Audio Coaxial  
Digital cable  
(commercially  
available)

DIGITAL OUT

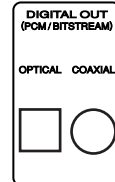

- **Method 1** DVD Player + Stereo system
- **Method 2** DVD Player + Dolby Digital decoder or DTS decoder

### NOTES (for method 2 only):

- When using an AV amplifier with a built in decoder (AV control center), Dolby Digital or DTS decoder as shown in the Method 2, set "DOLBY DIGITAL" or "DTS" to "BITSTREAM" accordingly for audio output in the setup menu (refer to page 24). Set it to "PCM" or "OFF" for the decoder that is not used currently. Playing a DVD using incorrect settings may generate noise distortion, and may also damage the speakers.
- The audio source on a disc in a Dolby Digital 5.1 channel surround format cannot be recorded as digital sound by an MD deck or DAT deck.
- Set "DOLBY DIGITAL" to "PCM", and "DTS" to "OFF" for audio output in the setup menu for connecting to an MD deck or DAT deck (refer to page 24).
- Harsh noise that could harm your ears or the speakers is generated when a DVD recorded in DTS is played while using a decoder, etc., that is not DTS-compatible.

### Optical cable (not supplied)

- Optical cable (not supplied) may be damaged when bent at sharp angles. Ensure cables are coiled in loops with a diameter of 6 inches (15cm) or more when storing them.
- Use a cable which is 9.8 feet (3m) or shorter.
- Insert cable plugs firmly into the connectors when making connections.
- If a plug has dust or is dirty, clean it with a soft cloth before inserting it into a connector.

## CONNECTIONS

### Connection to a TV (for video)

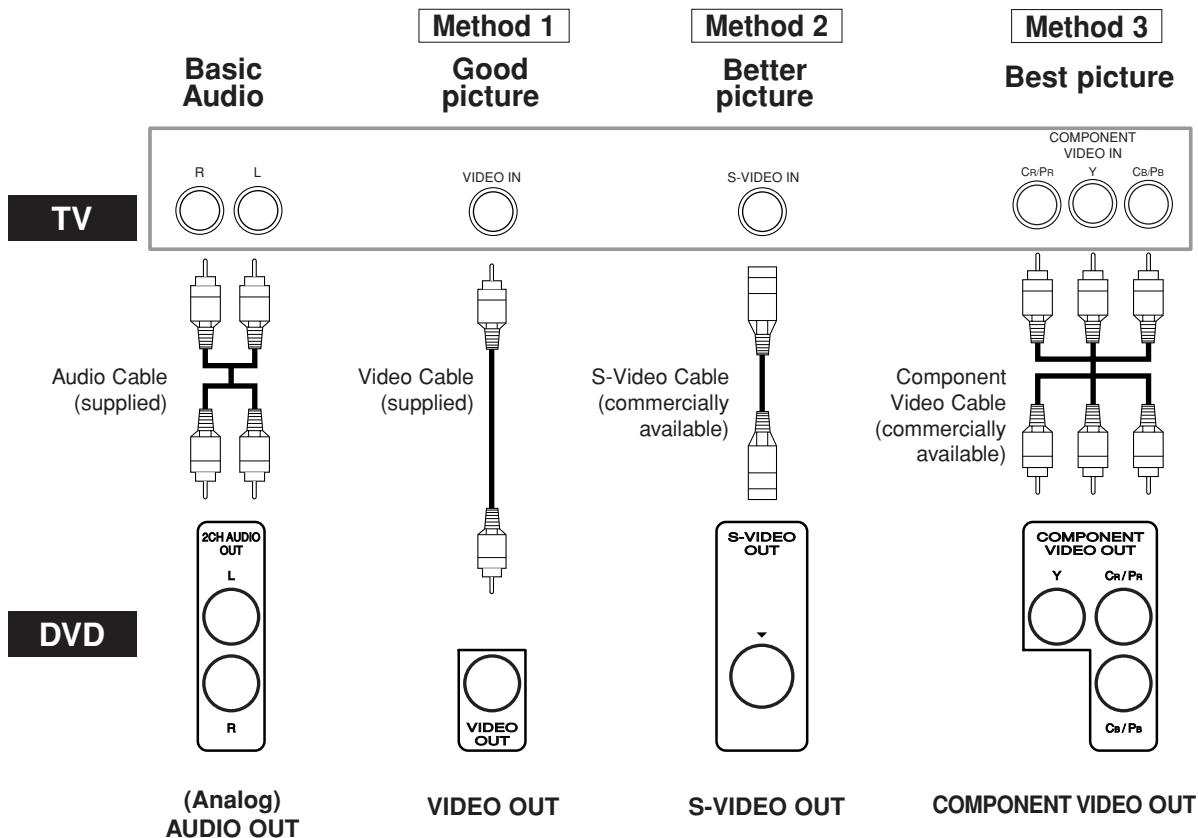

- **Method 1** DVD Player + TV with Video Input Jack
- **Method 2** DVD Player + TV with S-Video Input Jack
- **Method 3** DVD Player + TV with Component Video Jacks

#### NOTES:

- Connect the DVD player directly to a TV. If the Audio/Video cables are connected to a VCR, pictures may be distorted due to the copy protection system.
- S-Video output connector  
The video signals are divided into color (C) and brightness (Y) signals, achieving a clearer picture.  
If the TV is equipped with a S-Video input connector, we recommend connecting it to this unit's S-Video output connector using a commercially available S-Video connection cord.

#### HOW TO CONNECT TO A TV WITHOUT AUDIO/VIDEO INPUT JACKS

If your TV does not have RCA type audio and video input jacks it is still possible to connect this DVD player to your TV's 75-ohm coaxial antenna terminal using an optional Stereo Audio/Video RF Modulator, not included. Connect the audio and video outputs of the DVD player to the audio and video inputs on the RF Modulator, and then connect the coaxial output of the RF Modulator (usually marked "TO TV") to the 75 ohm coaxial antenna terminal on your TV. Follow the instruction supplied with the RF Modulator for more details.

If your TV's 75 ohm coaxial antenna terminal is already occupied by an antenna or cable box connection, remove that cable from your TV's antenna terminal and reconnect it to the coaxial antenna input terminal of the RF Modulator (usually marked "ANT IN"), then connect the RF modulator to your TV's antenna terminal as described above.

#### NOTE:

- The picture quality from DVD discs will not be as good if the DVD player is connected to the TV's antenna terminal through an RF Modulator.



## PLAYING A DISC

## Basic Playback

DVD-V DVD-RW VCD CD MP3  
JPEG WMA

## Getting started

- Turn on the power of the TV, amplifier and any other components which are connected to the DVD player.
- Make sure the TV and audio receiver (commercially available) are set to the correct channel.

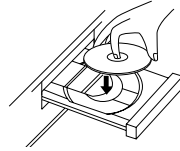

- 1 Press the **POWER** button.
  - "P-ON" will appear briefly on the display panel.
- 2 Press the **OPEN/CLOSE** button to open disc loading tray.
- 3 Place the disc in the tray, with the label facing up.
- 4 Press the **PLAY** button.
  - The tray will close automatically, and playback will then start from the first chapter or track of the disc. If the playback does not start automatically, press the **PLAY** button.
  - When you play back the DVD with a title menu, it may appear on the screen. In this case, refer to "Title Menu".
- 5 Press the **STOP** button to stop playback.

## NOTES:

- A "prohibited icon" may appear at the top-right on the TV screen during operation, warning that a prohibited operation has been encountered by the DVD player or the disc.
- With DVDs that use some titles for playback program signals, playback may start from the second title, or it may skip these titles.
- During the playback of two layered disc, pictures may stop for a moment. This happens when the 1st layer switches to the 2nd layer. This is not a malfunction.
- The operation may vary when you playback DVDs with disc menu or Video CDs with PBC. Refer to the manual accompanying the disc for details.
- A DVD-RW disc recorded in the VR mode may freeze momentarily during playback depending on how the playlist was made and edited (deleted titles, repeated recording).



## CANCELLING AND CALLING BACK THE PBC FUNCTION

VCD

- 1 Insert a Video CD.
- 2 Press the **STOP** button.
- 3 Press the **Numeric** buttons to enter the desired track number.
  - The PBC function is now cancelled and the playback of the Video CD will start.
- 4 To call back the PBC function, press the **STOP** button twice, and then press the **PLAY** button.
  - Title Menu will appear on the display.

## General Features

DVD-V

DVD may contain menus to navigate the disc and access special features. Press the appropriate **Numeric** buttons or use the **Cursor** buttons (▼/▲/▶/◀) to highlight your selection in the DVD main menu and press the **ENTER** button to confirm.

## NOTE:

- Unless stated, all operations described are based on remote control use. Some operations can be carried out using the menu bar on the TV screen.

## FL OFF Mode

- 1 Press the **FL OFF** button on the front panel to turn off the panel display.
  - The FL OFF indicator will light up.

## NOTES:

- In SETUP menu, the FL OFF mode is not available.
- The FL OFF mode will be released when you press the buttons listed below.
  - OPEN/CLOSE** button (on both the remote and the front panel), **SETUP**, **POWER** or **DISPLAY** button (on the remote), **POWER ON/STANDBY** or **FL OFF** button (on the front panel)

## Still / Pause

DVD-V DVD-RW VCD CD MP3  
JPEG WMA

- 1 During playback, press the **PAUSE** button.
  - Playback will pause and sound will be muted.
- 2 To continue playback, press the **PLAY** button.

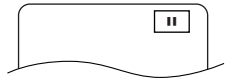

## NOTE:

- On DVDs, set "STILL MODE" to "FIELD" on the display menu if pictures in the Pause mode are blurred. (Refer to page 23.)

## Disc Menus

DVD-V

- 1 Press the **MENU** button.
  - The DVD main menu will appear.
- 2 If the feature is not available,  symbol may appear on the TV screen.
- 3 If disc menu is available on the disc, audio language, subtitle options, chapters for the title and other options will appear for selection.
- 4 Press the **Cursor** buttons (▼/▲/▶/◀) to select an item, and the **ENTER** button to confirm selection.

## Title Menu

DVD-V

- 1 Press the **TOP MENU** button.
  - The Title Menu will appear.
- 2 If the feature is not available,  symbol may appear on the TV screen.
- 3 Press the **Cursor** buttons (▼/▲/▶/◀) to select an item, and the **ENTER** button to confirm selection.
  - Playback will begin at the selected title.

VCD

- 1 When playing a Video CD with PBC function, the Title Menu will appear automatically.
- 2 Press the **Numeric** buttons to select the desired title.
  - Playback will begin at the selected title.
- 3 Press the **RETURN** button to go back to the title Menu.

## CALLING UP A MENU SCREEN DURING PLAYBACK

DVD-V

- Press the **MENU** button to call up the DVD main menu.
- Press the **TOP MENU** button to call up the Title Menu.

## NOTE:

- Contents of menus and corresponding menu operations may vary between discs. Refer to the manual accompanying the disc for details.

## PLAYING A DISC

### Step by Step Playback

DVD-V DVD-RW VCD

- 1 During playback, press the **PAUSE** button.

- Playback will pause and sound will be muted.

- 2 The disc advances by one frame each time the **PAUSE** button is pressed.

- 3 To exit Step by Step Playback, press the **PLAY** button.

#### NOTE:

- On DVDs, set "STILL MODE" to "FIELD" on the display menu if pictures in the Pause mode are blurred. (Refer to page 23.)

### Resume

DVD-V DVD-RW VCD CD MP3  
JPEG WMA

- 1 During playback, press the **STOP** button.

- Resume message will appear on the TV screen.

- 2 Press the **PLAY** button, playback will resume from the point at which playback was stopped.

- To cancel Resume, press the **STOP** button twice.

#### NOTES:

- Some Video CDs with the PBC function resume playback from the beginning of the track.
- The resume information will be saved even when the power is switched off.
- For MP3, JPEG or WMA, playback will resume from the beginning of the current track.

### Playing the disc recorded in VR mode (Video Recording format)

DVD-RW

DVDs recorded in VR mode can have a PLAYLIST assigned to alter the order or content to be played. If a PLAYLIST has been created, you can choose the ORIGINAL or PLAYLIST option.

- 1 Press the **MENU** button in Stop mode.
  - The current setting screen will appear.
  - Pressing the **MENU** button during playback is not valid.

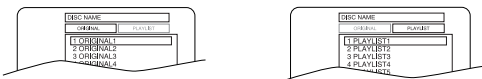

- 2 Press the **Cursor** buttons (◀ or ▶) to select ORIGINAL or PLAYLIST.
  - PLAYLIST will not be displayed when it has not been made.
  - Resume playback will not be possible if you change the setting.

- 3 Press the **Cursor** buttons (▲ or ▼) to select a title, then press the **ENTER** button.
  - Playback will start.

#### NOTE:

- [ORIGINAL]: A list of titles which are recorded with a DVD recorder.
- [PLAYLIST]: A list of titles which is made based on the ORIGINAL edited list.

### Fast Forward / Reverse Search

DVD-V DVD-RW VCD CD MP3  
WMA

- 1 During playback, press the **FWD** ▶▶ or **REV** ◀◀ button repeatedly to select the required forward or reverse speed.
  - For DVDs, Fast Forward or Reverse Search speed is different depending on the disc. The approximate speed is 1 (x2), 2(x8), 3 (x20), 4 (x50) and 5 (x100).

#### REV ◀◀ Button



#### FWD ▶▶ Button

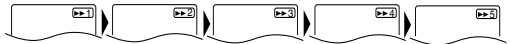

- For Video CDs, Audio CDs, MP3 and WMA, Fast Forward or Reverse Search speed is different depending on the disc. The approximate speed is 1(x2), 2(x8) or 3(x30).

- 2 To return to normal playback, press the **PLAY** button.

### Slow Forward / Slow Reverse

DVD-V DVD-RW VCD

- 1 During playback, press the **PAUSE** button.

- 2 Press the **FWD** ▶▶ or **REV** ◀◀ button.

- Slow motion playback will begin and sound will be muted.

- 3 Press the **FWD** ▶▶ or **REV** ◀◀ button repeatedly to select the required speed.

- Slow Forward or Reverse speed is different depending on the disc. Approximate speed is 1 (1/16), 2 (1/8), and 3 (1/2).

- 4 To return to normal playback, press the **PLAY** button.

#### NOTES:

- On DVDs, set "STILL MODE" to "FIELD" on the display menu if pictures in the Pause mode are blurred. (Refer to page 23.)
- Only Slow Forward is available when playing Video CD.

### Zoom

DVD-V DVD-RW VCD JPEG

The Zoom function allows you to enlarge the video image and to pan through the enlarged image.

- 1 Press the **ZOOM** button during playback.

- Playback will continue.

- 2 Press the **ZOOM** button repeatedly to select the required zoom factor: x2, x4 or off.

- Only x2 zoom is available on Video CDs and JPEG.



- 3 Use the **Cursor** buttons (▼ / ▲ / ▶ / ◀) to move the zoomed picture across the screen.

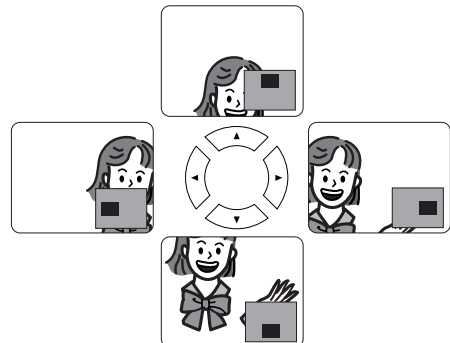

- 4 To exit Zoom mode, press the **ZOOM** button.

#### NOTES:

- Zooming function does not work while disc menu is shown.
- x4 zoom is not available on some discs.
- Playback will pause in the Zoom mode on JPEG.
- Navigation screen is not available on JPEG.
- You cannot move the zoomed picture on some JPEG files.

PLAYING A DISC

Title / Chapter Search

DVD-V DVD-RW

By using the SEARCH MODE button

- 1 Press the **SEARCH MODE** button repeatedly until the Chapter Search, or the Title Search appears during playback.

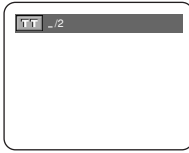

- 2 Enter the desired chapter/title number with the **Numeric** buttons.

By using the SKIP buttons

During playback, press the **SKIP** button to move to the next chapter. Press it repeatedly to skip subsequent chapters. Press the **SKIP** button to go back to the beginning of the current chapter. Press it repeatedly to go to the previous chapter.

- Chapter number will appear briefly on the front display panel.
- If the **SKIP** button is pressed while the playback is paused, the playback after skipping to the next chapter will be also paused.

Notes:

- Depending on the disc being played, the **Numeric** buttons can be used to search for a desired chapter by entering the chapter number directly. Refer to the manual accompanying the disc.
- The **SKIP** buttons are not available when playback is stopped.
- A disc that does not contain chapters within titles, the **SKIP** buttons change the titles.

Track Search

VCD CD MP3 JPEG WMA

There are three ways to begin playback on an Audio CD, Video CD, MP3, JPEG or WMA disc at a specific track.

By using the SEARCH MODE button

- 1 Press the **SEARCH MODE** button.
- 2 Within 30 seconds, select a desired track number using the **Numeric** buttons.

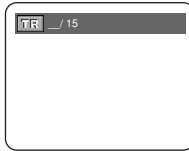

- The Track Search display appears.
- For the disc with less than 10 tracks, press the track number directly.
- For discs with 10 or more but less than 100 tracks, to play a single-digit track, press **0** first, then the track number (e.g. for track 3, press **0, 3**). To play a double-digit track, press the track number.
- For discs with 100 or more tracks, to play a single- or a double-digit track, press **0** first, then the track number (e.g. for track 3, press **0, 0, 3**, and for track 26, press **0, 2, 6**). To play a triple-digit track, press the track number.
- Press the **CLEAR** button to erase the incorrect input.

NOTE:

- The **+10** button can also bring up the track search display except for the disc with less than 10 tracks. For such a disc, track search can be done by just pressing the track number.

By using the SKIP buttons

During playback, press the **SKIP** button to move to the next track. Press it repeatedly to skip subsequent tracks. Press the **SKIP** button to go back to the beginning of the current track. Press it repeatedly to go to the previous tracks.

- Track number will appear briefly on the panel display.
- If the **SKIP** button is pressed while the playback is paused, the playback will be paused again after skipping to the next track.

NOTE:

- The **SKIP** buttons are not available when playback is stopped.

Time Search

DVD-V DVD-RW VCD CD

- 1 Press the **SEARCH MODE** button until the Time Search screen appears on the TV screen.

- 2 Within 30 seconds, enter a desired disc time with the **Numeric** buttons.



- Playback will start at the specified time.
- For Time Search, "0" appears automatically when there is no need to enter a number. For example, "0:0 : \_" appears in the Time Search screen if the total time of the disc is less than 10 minutes.
- Press the **CLEAR** button to erase the incorrect input.

Repeat

- The **REPEAT** button is available only during playback.

REPEAT TITLE / CHAPTER

DVD-V

To activate the Repeat function, press the **REPEAT** button during playback.

- The Repeat mode changes as described below every time you press the button.

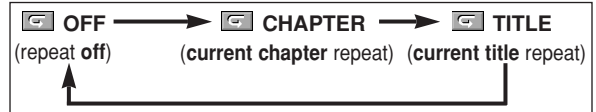

DVD-RW

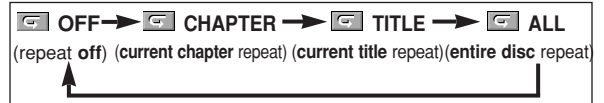

NOTES:

- The Repeat Title/Chapter setting will be cleared when moving to other title or chapter.
- Repeat playback does not function during A-B Repeat playback.
- Repeat Title/Chapter is not available with some scenes.
- "ALL" is not displayed when playing the DVD-RW discs recorded in Video mode.

## PLAYING A DISC

### REPEAT TRACK / GROUP / ALL

VCD CD

To activate the Repeat function, press the **REPEAT** button during playback.

- The Repeat mode changes as described below every time you press the button.



#### NOTES:

- The Repeat Track setting will be cleared when moving to other track.
- Repeat playback does not function during A-B Repeat playback.
- Repeat playback is not available when playing the Video CD with PBC function.

MP3 JPEG WMA

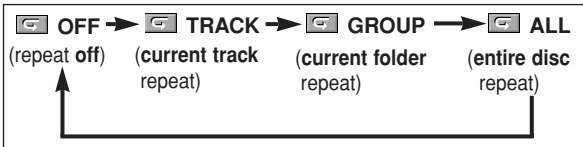

#### NOTE:

- The Repeat Track / Group setting will be cleared when moving to other track or group.

### A-B REPEAT

DVD-V DVD-RW VCD CD

- Press the **A-B REPEAT** button at your chosen starting point.
  - A** appears briefly on the TV screen.
- Press the **A-B REPEAT** button again at your chosen end point.
  - A-B** appears briefly on the TV screen, and the repeat sequence begins.
- To exit the sequence, press the **A-B REPEAT** button.

#### NOTES:

- The A-B Repeat section can only be set within the current title (for DVDs), or current track (for Audio CDs, Video CDs).
- A-B Repeat is not available with some scenes in DVD.
- To cancel the A point which was set, press the **CLEAR** button.
- A-B Repeat playback does not function during title, chapter, track or all repeat playback.

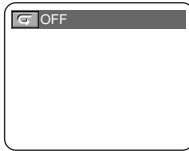
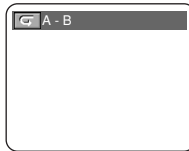
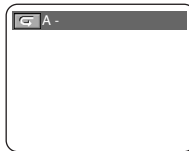

## Program Playback

CD

You may determine the order in which tracks will play.

- In Stop mode, press the **MODE** button.
  - The PROGRAM screen will appear.

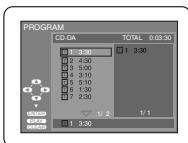

- Press the **Cursor** buttons (**▲** or **▼**) to select a track, then press the **ENTER** button.

- Press the **CLEAR** button to erase the most recently entered track.

- Press the **PLAY** button to start programmed playback.

#### NOTES:

- While the program is being played back, the **STOP** button works as follows.
- Press the **STOP** button once and then the **PLAY** button again, playback will restart from the point where the **STOP** button was pressed. (Program continued)
- Press the **STOP** button twice and then the **PLAY** button again, playback will restart from the first track in the usual way. Your programmes will be stored unless either the disc tray is opened or power is turned off.
- Up to 99 tracks can be entered.
- To erase all tracks in the program at once, select ALL CLEAR at the bottom of the list at step 2.
- If you wish to repeat the current track in the program, press the **REPEAT** button repeatedly until **TRACK** appears during playback. If you wish to repeat the entire program press the **REPEAT** button repeatedly until **ALL** appears during playback.
- Refer to page 20 for Program Playback of MP3, WMA, and JPEG.
- If eight or more tracks have been set in a program, the user can switch the right part of the screen with the **SKIP** **◀◀** or **▶▶** button.

## Random Playback

CD

This shuffles the playing order of tracks instead of playback in the original sequence.

- In Stop mode, press the **RANDOM** button.

- The RANDOM screen will appear.

- Press the **PLAY** button to start Random Playback.

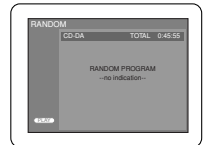

#### NOTES:

- If you wish to repeat the current track in the random selection, press the **REPEAT** button repeatedly until **TRACK** appears during playback. If you wish to repeat the entire random selection press the **REPEAT** button repeatedly until **ALL** appears during playback.
- You cannot go back to the previous track during Random Playback.
- Refer to page 21 for Random Playback of MP3, WMA, and JPEG.

## MP3 / JPEG / WMA Playback

MP3 JPEG WMA

When a CD-R or CD-RW disc with MP3, JPEG or WMA files is inserted in the DVD player and the **MENU** button is pressed, the FILE LIST will appear on display. The number of tracks is also displayed on the front panel.

- Press the **Cursor** buttons (**▲** or **▼**) to select the desired group (folder) or track.
  - If a group (folder) is selected, press the **Cursor** button (**▶**) or **ENTER** button to go on to the track selection screen. Press the **Cursor** buttons (**▲** or **▼**) to choose a track, then press the **PLAY** or **ENTER** button.
  - To return to the previous screen, press the **Cursor** button (**◀**).



## PLAYING A DISC

- If a track is selected, press the **PLAY** or **ENTER** button to start playing tracks. Starting from the one that has been chosen and the subsequent tracks will be played.
  - When selecting the folders:
    - Press the **Cursor** button (▶) when you want to go to the next hierarchy.
    - Press the **Cursor** button (◀) button when you want to go back to the previous hierarchy (except for the top hierarchy).
  - Press the **TOP MENU** button to return to the first item.
- 2** Press the **STOP** button to stop playback.

**NOTES:**

- Folders are known as Groups; files are known as Tracks.
- A symbol of "☐" is shown on the top of the group name.
- A symbol of "▶" is shown on the top of MP3 files.
- A symbol of "⊙" is shown on the top of JPEG files.
- A symbol of "■" is shown on the top of WMA files.
- Maximum of 255 folders can be recognized.
- If the track extends beyond the scope of screen, a down arrow "▼" appears, indicating that the user can view another part on the previous page. The current page number and the number of total pages are shown on the left of the down arrow "▼".
- Maximum of 999 files can be recognized.
- Up to 8 hierarchies can be recognized.
- If no MP3, JPEG or WMA files are found in the group, the group is not displayed.
- The DVD player can reproduce data recorded as per ISO 9660 Level 1, Level 2 or Joliet on the disc.
- It can also run a disc on which data is recorded in a multi-session.
- For more details of recording systems, refer to the instruction manual for the CD-R / CD-RW drive or the writing software.
- For MP3 and WMA file recorded in Variable Bit Rate (VBR), the unit may not display the actual elapsed time.

This player recommends the use of files recorded at the below specifications:

Applicable MP3 file		Remarks
Sampling frequency	44.1kHz 48kHz	• It is prohibited to record MP3 sound on a digital device when connection is made digitally.
Type	MPEG1 audio layer 3	• MP3 files recorded at fixed bit rate of 32 kbps or higher are recommended.
Applicable JPEG file		Remarks
Size of image	Upper limit: 6300x5100 dots Lower limit: 32x32 dots	• A JPEG image that extends beyond the screen is reduced so that it will be displayed within the screen.
Applicable WMA file		Remarks
Sampling frequency	44.1kHz 48kHz	• Those frequencies are applicable to WMA version 9.
Bit rate	48–192kbps	• Ensure that the copyright function is set to off when preparing a WMA disc.
Type	WMA version 9	• A prohibition "disable" symbol will appear if the user attempts to run a non-reproducible file such as copyright-protected. • Recorded in 5.1 channel format cannot be played back.

**Information on MP3, JPEG and WMA discs**

- This DVD player can play back images and sounds from data recorded in MP3 and JPEG formats on CD-R and CD-RW discs.
  - A file with an extension of ".mp3 (MP3)" is called an "MP3 file".
  - A file with an extension of ".jpg (JPG)" or ".jpeg (JPEG)" is called a "JPEG file".
- The DVD player can run an image file conforming to the Exif specification. Exif is a file format, Exchangeable Image File format established by Japanese Electronic Industry Development Association (JEIDA).
- A file with an extension of ".wma (WMA)" is called a "WMA file".
  - Files whose extension is other than ".mp3 (MP3)", ".jpg (JPG)" and ".jpeg (JPEG)" or ".wma (WMA)" will not be listed in the MP3, JPEG or WMA menu.
  - If the file is not recorded in MP3, JPEG or WMA format, noise may be produced even if the file extension is either ".mp3 (MP3)", ".jpg (JPG)", ".jpeg (JPEG)" or ".wma (WMA)".
  - The name of group and track can be displayed in up to 25 characters. Unrecognisable characters will be replaced with asterisks. The ninth and deeper hierarchies cannot be displayed.
  - Unplayable groups or tracks may be displayed depending on the recording conditions.
  - If the **TOP MENU** button is pressed when FILE LIST is displayed, the first item will be highlighted.

**Kodak Picture CD**

The DVD player can also run JPEG files stored on Kodak Picture CDs. The Picture CD is a service to convert photographs taken by a conventional film camera into digital data and write the data on a CD. The user can enjoy picture images on the television set by playing back the Picture CDs. For details of Kodak Picture CD, contact a shop that deals with developing service of Kodak Inc.

- 1** Press the **MENU** button. Kodak Picture CD menu appears.

- If all menu items cannot be displayed in the screen scope, "▶▶" appears at the right bottom of the screen, indicating that the user can view remaining items on the next page. "◀◀" appears, it indicates that the user can view other items on the previous page. The track number of the currently highlighted item and the total tracks are shown at the center bottom of the screen.
- If "▶▶" is shown at the right bottom, use the **SKIP ▶▶** button to view the next page. If "◀◀" is shown at the left bottom, use the **SKIP ◀◀** button to view the previous page.
- Press the **TOP MENU** button to get back to the first page.
- It may take some time until all menu items are displayed on the menu screen.

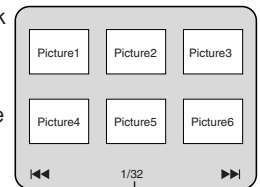

Current track number / the number of total tracks

- 2** Press the **Cursor** buttons (▼ / ▲ / ▶ / ◀), select a desired track to be played, then press the **PLAY** or **ENTER** button.
- If a Kodak Picture CD file is selected, an image will be played back from the selected track and go to the next one in turn.
- 3** Press the **STOP** button, to stop playback.

**Notes on JPEG and Kodak Picture CD:**

- A track is displayed for 5 or 10 seconds and then the next track is displayed. Refer to page 24 for SLIDE SHOW.
- Every press on the **Cursor** button (▶) will turn the image clockwise by 90 degrees when an image is displayed. A press on the **Cursor** button (◀) will turn the image counterclockwise by 90 degrees.
- To change the size of the playback image, press the **MODE** button twice. The size change mode appears on top of the TV screen during playback. Then press the **Cursor** buttons (◀ or ▶) or **ENTER** button to switch between **NORMAL** (100%) and **SMALL** (95%).
- Progressive JPEGs (JPEG files saved in the progressive format) will not be played back on this DVD player.
- High resolution JPEG files takes longer to be displayed.
- The size change mode may have no effect on some files (e.g. files with a small picture size).

**Notes on WMA:**

- The DVD player can reproduce data recorded as ISO 9660 level 2 with 31 characters file name included punctuation marks. The name of file can be displayed in up to 25 characters.
- Maximum of 8 subfolders can be recognized.
- It can also display tag information of WMA 64 characters at maximum.
- A file with an extension of Joliet as Unicode format in up to 64 characters can be recognized.
- This unit cannot play back copyright protected WMA files.

**Slide Show Mode**

JPEG

You can switch to the Slide Show Mode during playback.

- 1 Press the **MODE** button during playback.
  - The Slide Show Mode screen will appear.
  - The Slide Show Mode cannot be switched when it is stopped, or from the FILE LIST screen or the Picture CD menu screen.
- 2 Press the **Cursor** buttons (◀ or ▶) or **ENTER** button.
  - The Slide Show Mode will change.
  - **CUT IN/OUT:** The entire image appears in one time.
  - **FADE IN/OUT:** The image appears gradually and then disappears.
- 3 Press the **MODE** button twice to exit.

**On-Screen Information**

MP3 JPEG



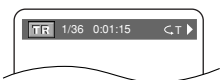

You can check each file during playback.

- 1 Press the **DISPLAY** button.
  - The name of the file currently in play will be displayed.

<Example: MP3>
- 2 Press the **DISPLAY** button again to show the track number, the elapsed time (MP3 only), the repeat status, and the playback status at the top of the screen.
  - ◁ will be displayed when the repeat playback has been selected.
  - ◁ T - indicates Track repeat
  - ◁ G - indicates Group (folder) repeat
  - ◁ A - indicates All (disc) repeat
- 3 Press the **DISPLAY** button again to exit.
  - During Program or Random Playback, each playback status will be displayed when you press the **DISPLAY** button. Then press the **DISPLAY** button again to exit.

WMA

You can check each file during playback.

- 1 Press the **DISPLAY** button.
  - The name of the file currently in play will be displayed.
- 2 Press the **DISPLAY** button again.
  - Title name based on tag information currently in play will be displayed.
- 3 Press the **DISPLAY** button again.
  - Artist name based on tag information currently in play will be displayed.
- 4 Press the **DISPLAY** button again to show the track number, the elapsed time, the repeat status, and the playback status at the top of the screen.
  - ◁ will be displayed when the repeat play has been selected.
  - ◁ T - indicates Track repeat
  - ◁ G - indicates Group (folder) repeat
  - ◁ A - indicates All (disc) repeat
- 5 Press the **DISPLAY** button again to exit.
  - During Program or Random Playback, each playback status will be displayed when you press the **DISPLAY** button. Then press the **DISPLAY** button again to exit.

**NOTE:**

- If the file does not contain tag information, "NOT AVAILABLE" will be displayed.

**Program Playback**

MP3 JPEG WMA

This feature allows you to program an MP3, JPEG or WMA disc to play in a desired sequence.

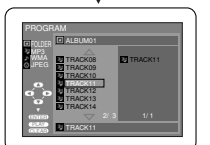
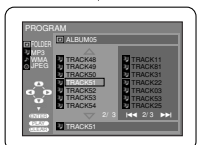
- 1 In Stop mode, press the **MODE** button.
  - The PROGRAM screen will appear.
- 2 Press the **Cursor** buttons (▲ or ▼) to select a group, then press the **Cursor** button (▶) or **ENTER** button.
  - A track selection screen appears.
- 3 Press the **Cursor** buttons (▲ or ▼) to select a track, then press the **ENTER** button to save it in a program.
  - Press the **CLEAR** button to erase the most recently entered track.
  - The programmed track is displayed in the right-hand screen.
  - If the entire program cannot be displayed at once on the screen, "▼" appears to go to the next page.
  - Pressing the **Cursor** button (◀) will show a list of folders that belong to the one-level upper hierarchy than the currently selected folder.
- 4 Press the **PLAY** button to start programmed playback.

**NOTES:**

- To erase all tracks in the program at once, select ALL CLEAR at the bottom of the list at step 2.



## PLAYING A DISC

- Press the **RETURN** button, and the STOP screen will show up with the program contents in memory.
- Press the **STOP** button once and then press the **PLAY** button, playback will restart from the beginning of the track being played previously. (program continued.)
- Press the **STOP** button twice and then the **PLAY** button again, playback will restart from the first track in the usual way. Your programmes will be stored unless either the disc tray is opened or power is turned off.
- Up to 99 tracks can be set in a program.
- If an inserted disc contains mixed MP3, JPEG and WMA files, Program function allows 99 tracks in combination of MP3, JPEG and WMA files.
- If eight or more tracks have been set in a program, the user can switch the right part of the screen with the **SKIP** ◀◀ or ▶▶ button.

### Random Playback

**MP3** **JPEG** **WMA**

- 1** In Stop mode, press the **RANDOM** button.
  - The RANDOM screen will appear.
- 2** Press the **PLAY** button to start Random Playback.
  - For a disc containing mixed MP3, JPEG and WMA files, Random Play of those files will be performed.

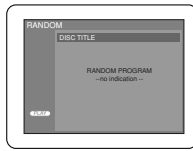

### Audio Language

**DVD-V** **DVD-RW**

The DVD player allows you to select a language during DVD disc (if multi language available) playback.

- 1** Press the **AUDIO** button during playback.
- 2** Press the **AUDIO** button repeatedly to select your desired language.

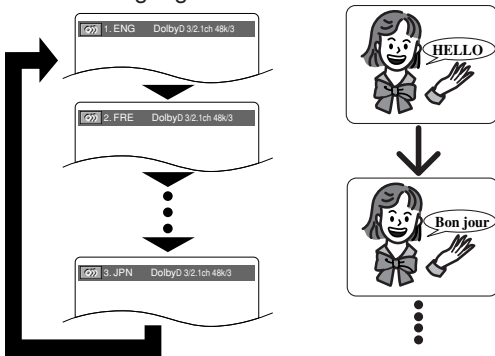

#### NOTES:

- The sound mode cannot be changed during playback of discs not recorded in double sound.
- Some discs allow Audio Language setting on the disc menu. (Operation varies between discs. Refer to the manual accompanying the disc.)
- Pressing the **AUDIO** button may not work on some DVDs with multiple audio languages (e.g. DVDs which allow Audio Language setting on the disc menu).
- If you choose a Language that has a 3-letter language code, the code will be displayed every time you change the Audio Language setting. If you choose any other languages, '---' will be displayed instead. (Refer to page 25.)
- If the disc has no audio language, 'NOT AVAILABLE' will be displayed.
- For DVD-RW (VR mode), pressing the **AUDIO** button cycles the sound mode through MAIN, SUB and MAIN + SUB.
- For DVD-RW (VR mode) discs recorded in double sound (two languages) can be played back in sound mode of MAIN, SUB or MAIN + SUB.

- With the digital connection, the audio language of DVD-RW (VR mode) with double sound will not be affected even though you can change the setting on the display.

### Stereo Sound Mode

**VCD** **CD**

- 1** Press the **AUDIO** button repeatedly during playback to select between STEREO, L-ch or R-ch.
  - STEREO - both right and left channels are active (stereo)
  - L-ch - only left channel is active
  - R-ch - only right channel is active

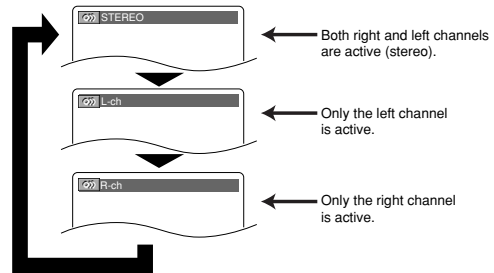

#### NOTE:

- Stereo sound mode cannot be changed when playing DTS CD.

### Subtitle Language

**DVD-V**

The DVD player allows you to select a language for subtitle during DVD disc (if available) playback.

- 1** Press the **SUBTITLE** button during playback.
- 2** Press the **SUBTITLE** button repeatedly to select your desired subtitle language.
  - The selected language will be displayed on the display bar at the top of the screen.
  - Press the **Cursor** buttons (◀ or ▶) to turn ON or OFF subtitles during playback.

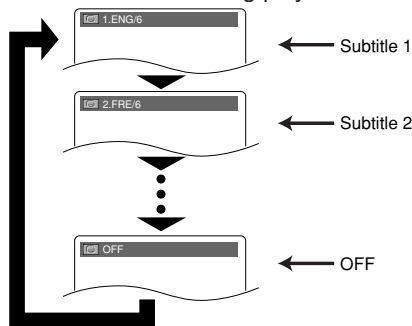

- 3** To turn off subtitles, press the **SUBTITLE** button repeatedly until OFF appears.

#### NOTES:

- Some discs allow Subtitle Language setting on the disc menu. (Operation varies between discs. Refer to the manual accompanying the disc.)
- Pressing the **SUBTITLE** button may not work on some DVDs with multiple subtitle languages (e.g. DVDs which allow Subtitle Language setting on the disc menu).
- If the desired language is not shown after pressing the **SUBTITLE** button several times, the disc does not have subtitles in that language.
- If you choose a Language that has a 3-letter language code, the code will be displayed every time you change the Subtitle Language setting. If you choose any other languages, '---' will be displayed instead. (Refer to page 25.)
- If the disc has no subtitle language, 'NOT AVAILABLE' will be displayed.

**Camera Angle**

DVD-V

Some DVD discs contain scenes which have been shot simultaneously from various angles. You can change the Camera Angle when the mark (  ) appears on the screen.

- 1 Press the **ANGLE** button during playback.
  - The selected angle will be displayed on the display bar at the top of the screen.
- 2 Press the **ANGLE** button repeatedly to select your desired angle.

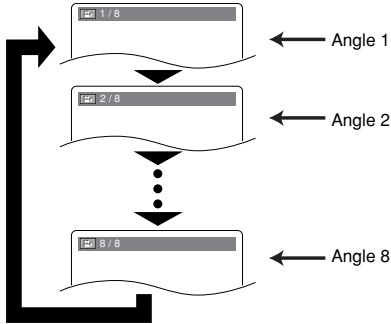

**NOTE:**  
 • If the "ANGLE ICON" setting is "OFF" in the Display menu, the mark (  ) will not appear.

**Changing the On-Screen Display**

DVD-V DVD-RW

You can check information about the current disc by pressing the **DISPLAY** button on the remote control.





- 1 Press the **DISPLAY** button during playback to show the current chapter.
  - The elapsed and remaining playing time of the current chapter will be displayed.
- 2 Press the **DISPLAY** button again to show the current title.
  - The elapsed and remaining playing time of the current title will be displayed.
- 3 Press the **DISPLAY** button again to show the BIT RATE and the current repeat setting.
  - If you are playing a dual layered disc, the layer number will also be displayed (L0: Layer 0 is playing. L1: Layer 1 is playing).
  - If you are playing a DVD-RW with setting the PLAYLIST, the following will also be displayed. ORG: Playing the ORIGINAL. PL: Playing the PLAYLIST.
- 4 Press the **DISPLAY** button again to remove the display.



VCD CD

- 1 Press the **DISPLAY** button during playback, the current track will be displayed on the TV screen.
  - The elapsed and remaining playing time of the current track will be displayed.
- 2 Press the **DISPLAY** button again to show the total tracks.
  - The elapsed and remaining playing time of the disc will be displayed.
- 3 Press the **DISPLAY** button again to remove the display.





**Hints for the On-Screen Display**

-  C - indicates Chapter repeat
-  T - indicates Title or Track repeat
-  A - indicates All (disc) repeat
-  A-B - indicates A-B repeat



**Marker Setup Screen**

DVD-V DVD-RW VCD CD

Use markers to memorise your favourite places on a disc.

- 1 Press the **SEARCH MODE** button repeatedly until the display screen and Markers appear during playback.
 
- 2 Press the **Cursor** buttons (  or  ) to select 1, 2, 3, 4, 5, 6, 7, 8, 9, or 10 and ensure that " \_ : \_ : \_ " appears in the display.
- 3 When reaches the desired point, press the **ENTER** button.
  - The title or track and elapsed playing time will appear in the TV screen.
- 4 To return to the Marker later, press the **SEARCH MODE** button repeatedly during playback and the **Cursor** buttons (  or  ) to choose the desired marker, then press the **ENTER** button.

**NOTES:**



- Opening the disc tray or turning off the power or select AC at step 2 and press the **ENTER** button will erase all Markers.
- To clear a marker, using the **Cursor** buttons (  or  ), position the cursor on to the marker number to be cleared and press the **CLEAR** button.
- You can mark up to 10 points.

- 5 Press the **SEARCH MODE** or **RETURN** button to exit.

**Virtual Surround**

DVD-V DVD-RW VCD CD MP3 WMA

You can enjoy stereophonic virtual space through your existing 2 channel stereo system.

- 1 During playback, press the **MODE** button repeatedly until Virtual Surround setting appears.
 
- 2 Press the **Cursor** buttons (  or  ) or **ENTER** button to set it 1(Natural effect), 2(Emphasised effect) or OFF.
- 3 Press the **MODE** or **RETURN** button to exit.

**NOTES:**

- You can also use the **VIRTUAL** button on the front panel. Press it repeatedly to select the required effect: 1, 2 or OFF.
- Select Virtual Surround OFF or adjust the volume down if the sound is distorted.
- Virtual Surround will not be effective if the sound mode is set to something other than "STEREO". (for Audio CDs or Video CDs play only)
- The setting will be saved even if the player is turned off.

**Black Level Setting**

DVD-V DVD-RW VCD

Adjust the Black Level Setting to make the black parts of the picture as bright as you prefer.

- 1 Press the **MODE** button during playback.
- 2 Press the **Cursor** buttons (  or  ) or **ENTER** button to switch ON/OFF.
  - ON (Default) : Makes the dark parts brighter.
  - OFF : Shows the original picture as recorded.

- 3 Press the **RETURN** button to exit.

**NOTE:**

- The setting will be saved even if the player is turned off.

In Setup menu, QUICK mode, CUSTOM mode and INITIALIZE mode are available (refer to pages 23-24). QUICK mode consists of the setting menus often needed, and you can make all settings required in CUSTOM mode. You can make the settings of the items with **QUICK** mark in QUICK mode.

### Language Setting

Language options are not available with some discs.

- 1 Press the **SETUP** button in Stop mode.
- 2 Press the **Cursor** buttons ( ◀ or ▶ ) to select CUSTOM, then press the **ENTER** button.
  - The CUSTOM mode will appear.
- 3 Press the **Cursor** buttons ( ◀ or ▶ ) to select LANGUAGE, then press the **ENTER** button to confirm.
- 4 Press the **Cursor** buttons ( ▲ or ▼ ) to select the below items, then press the **ENTER** button.



**AUDIO (Default : ENGLISH)**  
• Sets the audio language.

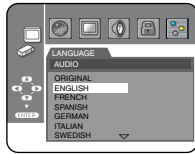

**SUBTITLE (Default : ENGLISH)**  
• Sets the subtitle language.

**DISC MENU (Default : ENGLISH)**  
• Sets the language for DVD Menu.

**PLAYER MENU (Default : ENGLISH) QUICK**

- Sets the language for the on-screen display.
- 5 Press the **Cursor** buttons ( ▲ or ▼ ) to select a setting, then press the **ENTER** button.
    - If OTHER is selected in the AUDIO, SUBTITLE or DISC MENU screen, press 4-digit number to enter the code for the desired language. (Refer to the Language Code List on page 25).
    - Only the languages supported by the disc can be selected.

6 Press the **SETUP** button to exit.

**NOTE:**  
• Language Setting for AUDIO and SUBTITLE is not available with some discs. Then use the **AUDIO** and **SUBTITLE** buttons. Details are on page 21.

### Display Setting

You can change certain aspects of the DVD display screens, on-screen messages and the display panel on the front of the DVD player.

- 1 Press the **SETUP** button in Stop mode.
- 2 Press the **Cursor** buttons ( ◀ or ▶ ) to select CUSTOM, then press the **ENTER** button.
  - The CUSTOM mode will appear.
- 3 Press the **Cursor** buttons ( ◀ or ▶ ) to select DISPLAY, then press the **ENTER** button to confirm.
- 4 Press the **Cursor** buttons ( ▲ or ▼ ) to select the below items, then press the **ENTER** button.



**TV ASPECT (Default : 16:9 WIDE) QUICK**

- Press the **Cursor** buttons ( ▲ or ▼ ) for an item selection, then press the **ENTER** button.
- Select 16:9 WIDE if a wide-screen TV is connected to the DVD player.
- Select 4:3 LETTER BOX for a black bars appears on top and bottom of the screen.
- Select 4:3 PAN & SCAN for a full height picture with both sides trimmed.

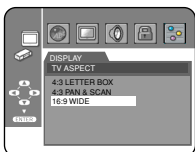

### STILL MODE (Default : AUTO)

- Press the **Cursor** buttons ( ▲ or ▼ ) for an item selection (AUTO, FIELD, or FRAME), then press the **ENTER** button.
- This adjusts the resolution of pictures in the still (PAUSE) mode.
- If you select AUTO, automatically select the best resolution setting (FRAME or FIELD) based on the data characteristics of the pictures. (default).
- If you select FIELD, pictures in the Still mode will be stabilized although they will be coarse due to little amount of data.
- If you select FRAME, pictures in the Still mode will be highly defined although they will be blurred due to output of two fields at the same time.

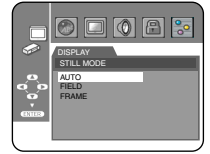

**NOTE:**

• An individual picture on TV screen is called as “frame”, which consists of two separate images called as “field”. Some pictures may be blurred at the AUTO setting in the Still mode due to their data characteristics.

### PROGRESSIVE (Default: OFF) QUICK

- Press the **Cursor** buttons ( ▲ or ▼ ) to set PROGRESSIVE to ON or OFF, then press the **ENTER** button.
- The setting will be effective when you exit the setup screen by pressing the **SETUP** button.
- When PROGRESSIVE is ON, “P.SCAN” appears on the DVD player’s display.
- Refer to page 12 for more details.

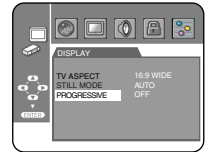

5 Press the **SETUP** button to exit.

**NOTE:**

• Be sure to press the **SETUP** button, or the setting will not work.

### Audio Setting

Choose the appropriate Audio settings for your equipment as it only affect during the playback of DVD discs of the DVD player.

- 1 Press the **SETUP** button in Stop mode.
- 2 Press the **Cursor** buttons ( ◀ or ▶ ) to select CUSTOM, then press the **ENTER** button.
  - The CUSTOM mode will appear.
- 3 Press the **Cursor** buttons ( ◀ or ▶ ) to select AUDIO, then press the **ENTER** button to confirm.
- 4 Press the **Cursor** buttons ( ▲ or ▼ ) to select the below items, then press the **ENTER** button.

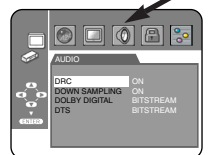

**DRC (Dynamic Range Control) (Default : ON)**

- To compress the range of sound volume.
- DRC function is available only on the discs that are recorded in the Dolby Digital format.

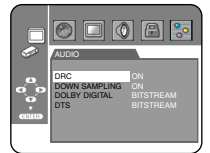

**DOWN SAMPLING (Default : ON)**

- Set to ON when outputting in 48kHz.
- This function is available only on digital outputting of a disc recorded in 96kHz.

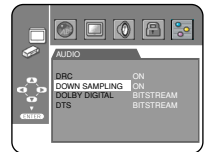

*When playing disc with copy-right protection*

- The sound will be down sampled at 48kHz, even if you set to OFF.

**DOLBY DIGITAL (Default : BITSTREAM) QUICK**

Set to BITSTREAM when the player is connected to Dolby Digital decoder.

**BITSTREAM:**

Output by Dolby Digital.

**PCM:**

Convert the Dolby Digital to PCM.

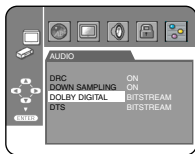

**DTS (Default : BITSTREAM) QUICK**

**BITSTREAM:**

Output by DTS sound. Set to BITSTREAM when the unit is connected to DTS decoder.

**OFF:**

No DTS sound will be output.

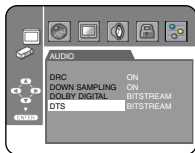

**5** Press the **SETUP** button to exit.

**Parental Control**

Parental Control limits playback of discs with unsuitable audience ratings. A 4-digit password established by the user will unlock the parental lock. This feature allows you to prevent your children from playing discs with objectionable scenes.

**PARENTAL LEVEL**

Parental Level allows you to set the rating level of your DVD discs. Playback will stop if the disc's ratings exceed the level you set.

- 1** Press the **SETUP** button in Stop mode.
- 2** Press the **Cursor** buttons (◀ or ▶) to select **CUSTOM**, then press the **ENTER** button.
  - The **CUSTOM** mode will appear.
- 3** Press the **Cursor** buttons (◀ or ▶) to select **PARENTAL**, then press the **ENTER** button.
- 4** Press the **Numeric** buttons to enter your 4-digit password.
  - When doing this for the first time, enter any 4-digit number by pressing the **Numeric** buttons (except for 4737), then press the **ENTER** button. That number will be used as the password from the second time onward. Record your password in case you forget it.
- 5** Press the **Cursor** buttons (▲ or ▼) to select **PARENTAL LEVEL**, then press the **ENTER** button.

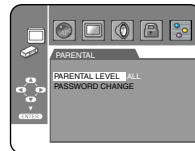
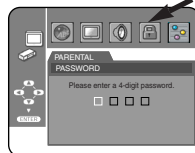

- 6** Press the **Cursor** buttons (▲ or ▼) to select the desired level, then press the **ENTER** button.
- 7** Press the **SETUP** button to exit.

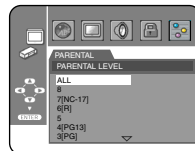

**NOTE:**

• This function may not work on some DVDs. Be sure if the ratings operates in the way you have set.

**To Change the Password:**

- 1) Follow the steps **1** to **4** above.
- 2) Press the **Cursor** buttons (▲ or ▼) to select "PASSWORD CHANGE", then press the **ENTER** button.
- 3) Enter a new 4-digit password, then press the **ENTER** button.
- 4) Press the **SETUP** button to exit.

**IF YOU FORGET THE PASSWORD**

- 1** Press **4, 7, 3, 7** at step **4**.
  - The original password will be cleared and the Parental Level will be set to "ALL". Enter a new 4-digit password, then press the **ENTER** button.
- 2** Repeat steps **5** to **7** to re-establish the Parental Level.

**CONTROL LEVELS**

- **ALL**  
Parental lock is cancelled.
- **Level 8**  
DVD softwares of any grades (adult/general/children) can be played back.
- **Levels 7 to 2**  
Only DVD softwares intended for general use and children can be played back.
- **Level 1**  
Only DVD softwares intended for children can be played back, with those intended for adult and general use prohibited.

**TIPS FOR LEVELS**

- **7 [NC-17]:** No one under 17 admitted
- **6 [R]:** Restricted; under 17 requires accompanying parent or adult guardian
- **4 [PG13]:** Unsuitable for children under 13
- **3 [PG]:** Parental Guidance suggested
- **1 [G]:** General Audience

**Others Setting**

This function allows you to adjust Angle Icon availability, Auto Power Off, brightness of the player's display panel, and Slide Show Mode.

- 1** Press the **SETUP** button in Stop mode.
- 2** Press the **Cursor** buttons (◀ or ▶) to select **CUSTOM**, then press the **ENTER** button.
  - The **CUSTOM** mode will appear.
- 3** Press the **Cursor** buttons (◀ or ▶) to select **OTHERS**, then press the **ENTER** button to confirm.
- 4** Press the **Cursor** buttons (▲ or ▼) to select an item, then press the **ENTER** button.



**ANGLE ICON (Default : ON)**

• Press the **ENTER** button repeatedly to turn ANGLE ICON ON or OFF.

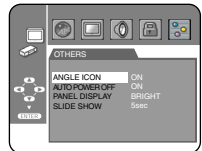

**AUTO POWER OFF (Default : ON)**

• Press the **ENTER** button repeatedly to turn AUTO POWER OFF ON or OFF.  
• It will turn the DVD player to off automatically after 30 minutes of no use.

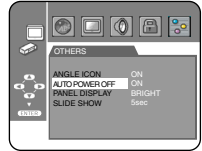

**PANEL DISPLAY (Default : BRIGHT)**

• Press the **Cursor** buttons (▲ or ▼) to select an item among **BRIGHT**, **DIMMER** and **AUTO**, then press the **ENTER** button.  
• When **AUTO** is selected, the display dims only during playback.



**SLIDE SHOW (Default : 5sec)**

• This adjusts the playback speed of the JPEG SLIDE SHOW.  
• Press the **Cursor** buttons (▲ or ▼) to select between 5 sec and 10 sec, then press the **ENTER** button.

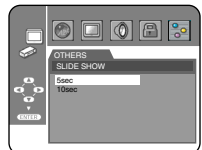

**5** Press the **SETUP** button to exit.

**Reset to the Default Settings (except for PARENTAL)**

This allows you to return all selections of **SETUP** (except for **PARENTAL**) to their default settings.

- 1** Press the **SETUP** button in Stop mode.
- 2** Press the **Cursor** buttons (◀ or ▶) to select **INIT.**, then press the **ENTER** button.
- 3** Press the **Cursor** buttons (▲ or ▼) to select **YES**, then press the **ENTER** button.
- 4** Press the **SETUP** button to exit.

**NOTE:**

• If you like to cancel initializing, select **NO** at step **3**.



Language Code List

Language	Code	Language	Code	Language	Code	Language	Code
<b>A-B</b>							
Abkhazian	4748	Frisian	5271	Malay	5965	Somali	6561
Afar	4747	Galician	5358	Malayalam	5958	Spanish [SPA]	5165
Afrikaans	4752	Georgian	5747	Maltese	5966	Sundanese	6567
Albanian	6563	German [GER]	5051	Maori	5955	Swahili	6569
Amharic	4759	Greek [GRE]	5158	Marathi	5964	Swedish [SWE]	6568
Arabic	4764	Greenlandic	5758	Moldavian	5961	<b>T</b>	
Armenian	5471	Guarani	5360	Mongolian	5960	Tagalog	6658
Assamese	4765	Gujarati	5367	Nauru	6047	Tajik	6653
Aymara	4771	Hausa	5447	Nepali	6051	Tamil	6647
Azerbaijani	4772	Hebrew	5569	Norwegian [NOR]	6061	Tatar	6666
Bashkir	4847	Hindi	5455	<b>O-R</b>		Telugu	6651
Basque	5167	Hungarian [HUN]	5467	Occitan	6149	Thai	6654
<b>I-K</b>							
Bengali;Bangla	4860	Icelandic [ICE]	5565	Oriya	6164	Tibetan	4861
Bhutani	5072	Indonesian	5560	Oromo(Afan)	6159	Tigrinya	6655
Bihari	4854	Interlingua	5547	Panjabi	6247	Tonga	6661
Bislama	4855	Interlingue	5551	Pashto;Pushto	6265	Tsonga	6665
Breton	4864	Inupiak	5557	Persian	5247	Turkish [TUR]	6664
Bulgarian	4853	Irish [IRI]	5347	Polish	6258	Turkmen	6657
Burmese	5971	Italian [ITA]	5566	Portuguese [POR]	6266	Twi	6669
Byelorussian	4851	Japanese [JPN]	5647	Quechua	6367	<b>U-Z</b>	
<b>C-E</b>							
Cambodian	5759	Javanese	5669	Rhaeto-Romance	6459	Ukrainian	6757
Catalan	4947	Kannada	5760	Romanian [RUM]	6461	Urdu	6764
Chinese [CHI]	7254	Kashmiri	5765	Russian [RUS]	6467	Uzbek	6772
Corsican	4961	Kazakh	5757	<b>S</b>		Vietnamese	6855
Croatian	5464	Kinyarwanda	6469	Samoan	6559	Volapuk	6861
Czech	4965	Kirghiz	5771	Sangho	6553	Welsh	4971
Danish [DAN]	5047	Kirundi	6460	Sanskrit	6547	Wolof	6961
Dutch [DUT]	6058	Korean [KOR]	5761	Scots Gaelic	5350	Xhosa	7054
English [ENG]	5160	Kurdish	5767	Serbian	6564	Yiddish	5655
Esperanto	5161	<b>L-N</b>		Serbo-Croatian	6554	Yoruba	7161
Estonian	5166	Laothian	5861	Sesotho	6566	Zulu	7267
<b>F-H</b>							
Faroese	5261	Latin	5847	Setswana	6660		
Fiji	5256	Latvian;Lettish	5868	Shona	6560		
Finnish [FIN]	5255	Lingala	5860	Sindhi	6550		
French [FRE]	5264	Lithuanian	5866	Singhalese	6555		
		Macedonian	5957	Siswat	6565		
		Malagasy	5953	Slovak	6557		
				Slovenian	6558		

If you choose a Language that has a 3-letter language code, the code will be displayed every time you change the Audio or Subtitle Language setting on page 21. If you choose any other languages, '---' will be displayed instead. (3-letter language code is written in bracket.)

MAINTENANCE

Cleaning the Cabinet

- Use a soft cloth slightly moistened with a mild detergent solution. Do not use a solution containing alcohol, spirits, ammonia or abrasives.

Cleaning Discs

- When a disc becomes dirty, clean it with a cleaning cloth. Wipe the disc from the center out. Do not wipe in a circular motion.
- Do not use solvents such as benzine, thinner, commercially available cleaners, detergent, abrasive cleaning agents or antistatic spray intended for analogue records.

Cleaning the disc lens

- If the player still does not perform properly when it is operated while referring to the relevant sections and to "TROUBLESHOOTING GUIDE" in this User Guide, the laser optical pickup unit may be dirty. Consult your dealer or an Authorized Service Center for inspection and cleaning of the laser optical pickup unit.

Disc Handling

- Use discs which have the following logos on them.
- Handle the discs so that fingerprints and dust do not adhere to the surfaces of the discs.
- Always store the disc in its protective case when it is not used.
- Note that discs with special shapes (heart-shaped discs, octagonal discs, etc.) cannot be played on this player. Do not attempt to play such discs, as they may damage the player.



## TROUBLESHOOTING GUIDE

If the DVD player does not perform properly when operated as instructed in this User Guide, check the player, consulting the following checklist.

<b>Problem</b>	<b>Solution</b>
<b>No power</b>	<ul style="list-style-type: none"> <li>–Check if the AC power cord is properly connected.</li> <li>–Unplug the outlet once, and wait for 5-10 seconds and then plug it in again.</li> </ul>
<b>No sound or picture</b>	<ul style="list-style-type: none"> <li>–Check if the TV is switched on.</li> <li>–Check the video connection.</li> <li>–Check the VIDEO/AUDIO cable connections to the TV. (Refer to on page 14 for Connecting to a TV (for video)).</li> <li>–Check if the PROGRESSIVE mode is set correctly. See pages 12 and 23.</li> </ul>
<b>Distorted picture</b>	<ul style="list-style-type: none"> <li>–Sometimes a small amount of picture distortion may appear. This is not a malfunction.</li> <li>–Connect the player directly to the TV.</li> <li>–Check if the PROGRESSIVE mode is set correctly. See pages 12 and 23.</li> </ul>
<b>Completely distorted picture or black/white picture with DVD</b>	<ul style="list-style-type: none"> <li>–Connect the player directly to the TV.</li> <li>–Make sure the disc is compatible with the player.</li> </ul>
<b>No sound or distorted sound</b>	<ul style="list-style-type: none"> <li>–Adjust the volume.</li> <li>–Check that the speakers are connected correctly.</li> </ul>
<b>No audio at digital output</b>	<ul style="list-style-type: none"> <li>–Check the digital connections.</li> <li>–Check the audio settings.</li> </ul>
<b>No DTS audio output</b>	<ul style="list-style-type: none"> <li>–Use a DIGITAL OUT jack when outputting the DTS audio.</li> </ul>
<b>Picture freezes momentarily during playback</b>	<ul style="list-style-type: none"> <li>–Check the disc for fingerprints/scratches and clean with a soft cloth wiping from center to edge.</li> <li>–Clean the disc.</li> </ul>
<b>Disc can't be played</b>	<ul style="list-style-type: none"> <li>–Clean the disc.</li> <li>–Ensure the disc label is facing up.</li> <li>–Check if the disc is defective by trying another disc.</li> <li>–Cancel the parental lock or change the control level.</li> <li>–Insert a correct disc that plays on this player.</li> <li>–Reset the player by switching the player off, then on again.</li> </ul>
<b>No return to start-up screen when disc is removed</b>	<ul style="list-style-type: none"> <li>–Reset the player by switching the player off, then on again.</li> </ul>
<b>The player does not respond to the remote control</b>	<ul style="list-style-type: none"> <li>–Aim the remote control directly at the sensor on the front of the player.</li> <li>–Reduce the distance to the player.</li> <li>–Replace the batteries in the remote control.</li> <li>–Re-insert the batteries with their polarities (+/- signs) as indicated.</li> </ul>
<b>Buttons do not work or the player stops responding</b>	<ul style="list-style-type: none"> <li>–To completely reset the player, unplug the AC cord from the AC outlet for 5-10 seconds.</li> </ul>
<b>The remote control doesn't seem to work</b>	<ul style="list-style-type: none"> <li>–The REMOTE CONTROL IN jack on the rear panel is connected.</li> <li>–Check that REMOTE CODE setting is set to the correct position.</li> </ul>
<b>The player does not respond to some operating commands during playback</b>	<ul style="list-style-type: none"> <li>–Operations may not be permitted by the disc. Refer to the instructions of the disc.</li> </ul>
<b>The player cannot read CDs/DVDs</b>	<ul style="list-style-type: none"> <li>–Use a commonly available cleaning CD/DVD to clean the lens before sending the player for repair.</li> </ul>
<b>Angle does not switch</b>	<ul style="list-style-type: none"> <li>–The angle cannot be switched for DVDs which do not contain multiple angles. In some cases multiple angles are only recorded for specific scenes.</li> </ul>
<b>Playback does not start when the title is selected</b>	<ul style="list-style-type: none"> <li>–Check the "PARENTAL" setting.</li> </ul>
<b>The password for rating level has been forgotten</b>	<ul style="list-style-type: none"> <li>–Enter the default password "4737", then your forgotten password will be cleared.</li> </ul>

### NOTES:

- Some functions are not available in specific modes, but this is not a malfunction. Read the description in this User Guide for details on correct operations.
- Playback from a desired track and Random Playback are not available during Program Playback.
- Some functions are prohibited on some discs.
- When playing Video CDs with PBC function, some operations (e.g., select and track repeat) cannot be performed. Cancel PBC function temporarily to perform those operations. See page 15.





**www.marantz.com**

You can find your nearest authorized distributor or dealer on our website.

---

<b>U.S.A</b>	Marantz America, Inc.	1100 Maplewood Drive, Itasca, IL 60143, U.S.A.
<b>EUROPE</b>	Marantz Europe B.V.	P.O. Box 8744, 5605 LS Eindhoven, The Netherlands

---

**marantz**<sup>®</sup> is a registered trademark.



2005/07

00M39BW851250